

SUPER AFC

Vehicle Specific Wiring Diagrams



● This manual lists vehicle applications and ECU wiring diagrams for the SUPER AFC (Product Code: 401-A007). Please read the instructions and safety precautions in the instruction manual.

● Both this manual and the instruction manual are needed to install this unit.

● Although this manual lists vehicle specific wiring diagrams, there may be some special models and applications that have not been included.

This manual was printed on April 1, 1999. Please contact your dealer of purchase to obtain wiring diagrams for specified vehicles produced after this date.

● This manual is intended for Japanese specification vehicles ONLY. Japanese vehicles sold in other countries MAY have different wiring diagrams and specifications. The Super AFC may not work properly in these cases.

■ To Begin

Please be sure to read the safety precautions in the instruction manual before installation.

Please refer to the signal words and their meanings in the instruction manual.

"ECU" stands for Electric Control Unit in this manual.



CAUTION

● **Installation should only be performed by an experienced installer.**

Please forward this manual, instruction manual and warranty card to the customer (user).

● **Do not pull the harness of the vehicle and this product.**

Failure to do so may cause product damage and vehicle damage caused by electrical shorts.

● **Be sure to release the lock of connector when handling.**

Also be sure to free the fixing bolt when releasing the connector.

Failure to do so may result connector damage.

● **Do not expose the connector to direct water, sunlight or heat.**

Failure to do so may result in electrical shorts that cause product damage and vehicle damage .

● **Keep the product and vehicle harness away and from sharp objects. Do not press the harnesses together**

Failure to do so may cause electrical shorts resulting in product damage and vehicle damage.

■ Table of Contents

■ To Begin	1
■ Table of Contents	2
■ Precautions for Installation	3
Correct Grounding Procedures	3
Incorrect Grounding Procedures	4
■ ECU Location Diagram	5
■ Angled View for ECU Wiring Diagram	6
■ Vehicle Application Table (TOYOTA)	7
■ ECU Wiring Diagram (TOYOTA)	10
■ Vehicle Application Table (NISSAN)	15
■ ECU Wiring Diagram (NISSAN)	18
■ Vehicle Application Table (MITSUBISHI)	20
■ ECU Wiring Diagram (MITSUBISHI)	21
■ Vehicle Application Table (HONDA)	22
■ ECU Wiring Diagram (HONDA)	23
■ Vehicle Application Table (MAZDA)	25
■ ECU Wiring Diagram (MAZDA)	26
■ Vehicle Application Table (SUBARU)	28
■ ECU Wiring Diagram (SUBARU)	29
■ Vehicle Application Table (SUZUKI)	30
■ ECU Wiring Diagram (SUZUKI)	31
■ Vehicle Application Table (ISUZU)	32
■ Vehicle Application Table (DAIHATSU)	32
■ ECU Wiring Diagram (ISUZU)	33
■ ECU Wiring Diagram (DAIHATSU)	33
■ Manual Information	34

■ Precautions for Installation

● Never use the electro-taps to install this product. Electro-taps may cause an unstable electric connection. Improper connections may cause the unit to function incorrectly causing severe damage to the vehicle. Be sure to use attached splitting caps and secure them with pliers.

● Be sure to cover all exposed connections with electrical tape

● It is very important to keep the voltage precise. Be sure to have the 2 separate Ground Wires (Black Wire and Brown Wire). Be sure to connect the Ground Wires exactly as shown below. Failure to do so may cause to damage not only to this product but also to the engine of installed vehicle.

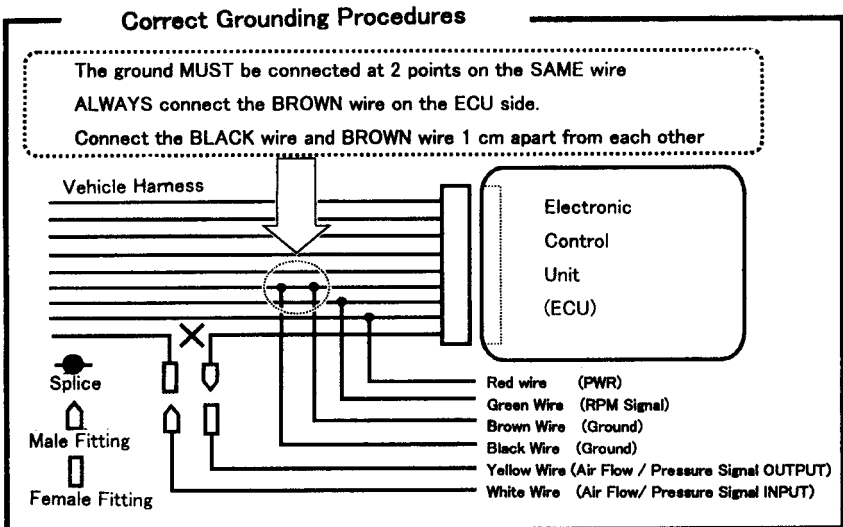

誤ったアースの接続方法

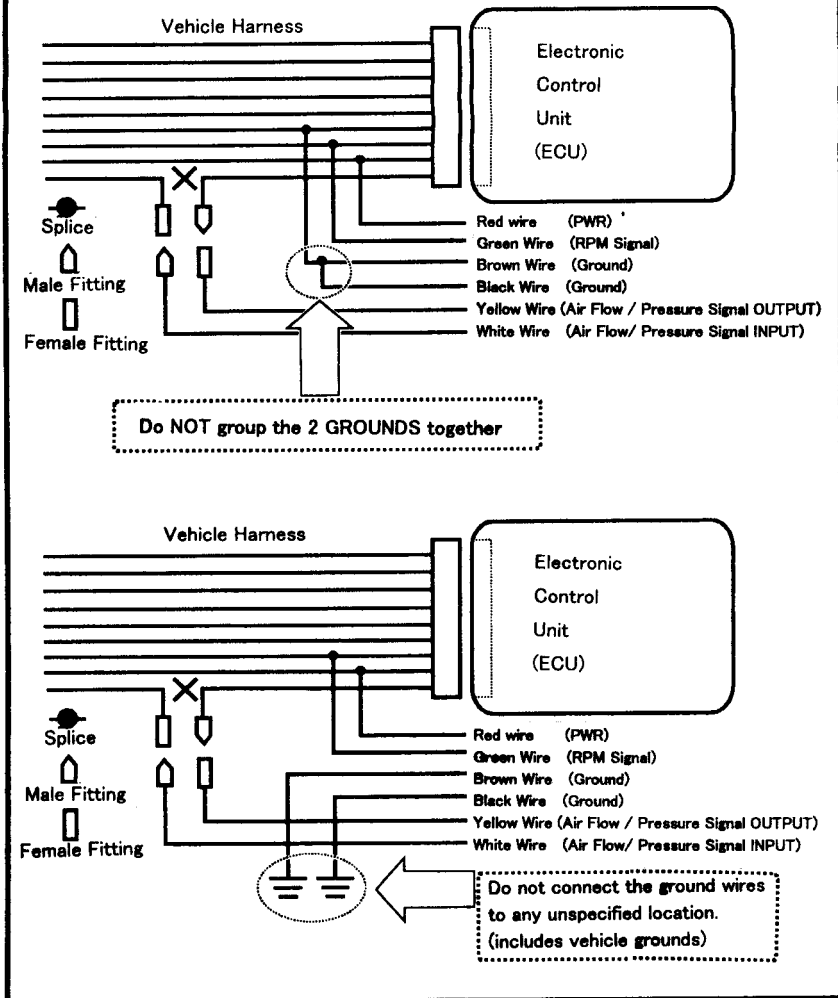

The illustration above shows the Ground Wire connection only.

Please read the instruction manual for other Signal Wire connections.

Be sure to connect all wires as shown in the instruction manual.

■ ECU Location Diagram

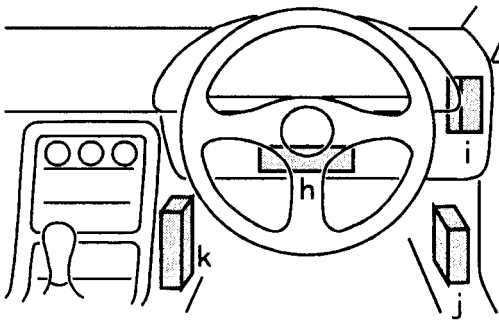
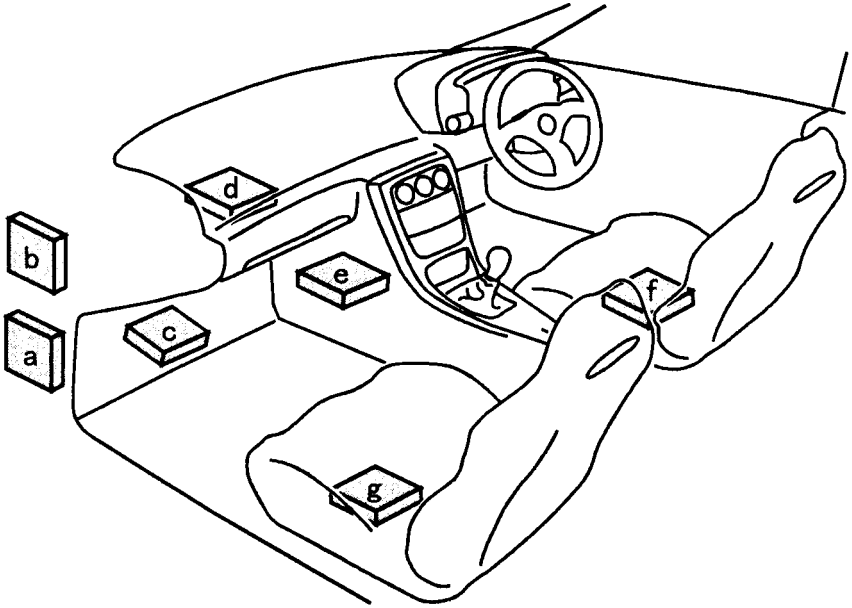

- a Passenger Side Lower Dash
- b Left of the Glove Box
- c Passenger Side Foot Rest
- d Behind the Glove Box
- e Behind the Center Console
- f Under the Driver Seat
- g Under the Passenger Seat
- h Near the Steering Column
- i Right of the Meter Panel
- j Driver Side Lower Dash
- k Right of the Center Console
- l Engine room
- m Front Side of the Rear Trunk
- n Back of the Driver Seat

■ Angle of View for ECU Wiring Diagram

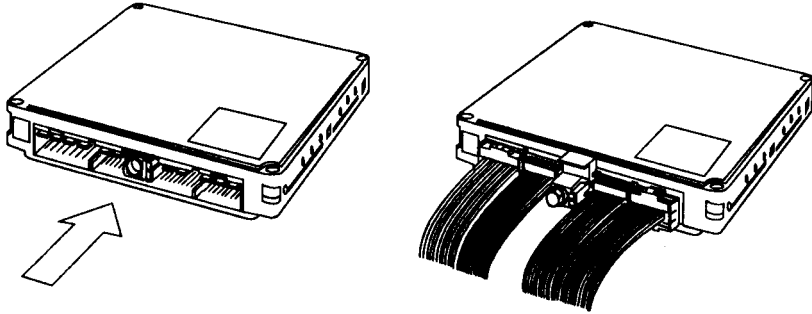

View the ECU Wiring Diagram from this angle.

Some vehicles may have the computer unit mounted backwards. Please be sure to count the number of pins before proceeding with installation.



WARNING

If any unusual odor or sound comes from the unit, discontinue use immediately and return the unit to the dealer of purchase.

Continued use may result in electrical shorts and electrical fires.

■ Vehicle Application Table (TOYOTA)

Vehicle Name	Model Type	Engine	Year	ECU Location	Note	Wiring Diagram
CELSIOR	UCF10	1UZ-FE	'92.9~'94.9	d		T8-a
	UCF11		'89.11~'92.8			T5-f
CROWN	JZS14#	2JZ-GE	'91.10~'95.7	d		T8-b
CROWN MAJESTA	UZS141	1UZ-FE	'91.10~'95.7	d		T7-b
ARISTO	JZS161	2JZ-GTE	'97.8~*	l		T10-a
	JZS160	2JZ-GE				
	JZS147	2JZ-GTE	'91.10~'97.7	c		T7-c
		2JZ-GE				
UZS143	1UZ-FE	'92.10~'97.7		T7-b		
SOARER	JZZ30	1JZ-GTE	'96.8~*	c		T8-d
			'91.5~'96.7			T8-a
	JZZ31	2JZ-GE	'94.1~'96.7	c		T8-c
	UZZ31	1UZ-FE	'91.5~'93.12			T7-a
	MZZ20	7M-GTE	'88.1~'91.4	d		T5-a
			'86.1~'87.12			T2-b
	GZZ20	1G-GTE	'88.1~'91.4	d		T5-a
			'86.1~'87.12			T2-e
1G-GE		'89.1~'91.4			T5-a	
		'86.1~'88.12			T2-d	
SUPRA	JZA80	2JZ-GTE	'97.8~*	c		T10-a
			'93.5~'97.7			T7-d
	JZA70	1JZ-GTE	'90.8~'93.4	d		T6-a
			'88.9~'90.7			T5-a
	MA70	7M-GTE	'86.2~'88.8	d		T2-b
			'88.8			Turbo A
	GA70	1G-GTE	'88.9~'93.4	d		T5-a
			'86.2~'88.8			T2-e
		1G-GE	'88.9~'93.4			T5-a
			'86.2~'88.8			T2-d
MARK II CRESTA CHASER	JZX100	1JZ-GTE	'96.9~*	e		T8-d
	JZX90		'94.9~'96.8			T8-g
			'92.10~'94.8			
	JZX91	2JZ-GE	'94.9~'96.8		T6-c	
	JZX81	1JZ-GE	'92.10~'96.8		T8-d	
			'90.8~'92.9		T8-a	
GX81	1JZ-GTE	'90.8~'92.9	d		T6-a	
	1G-GTE	'88.8~'92.9			T6-b	
	1G-GE	'88.8~'92.9			T5-a	
MR2	SW20Ⅲ~Ⅴ	3S-GTE	'93.10~*	m		T5-b
	SW20Ⅲ、Ⅳ	3S-GE	'93.10~'97.11			T6-d
	SW20Ⅰ、Ⅱ	3S-GTE	'89.10~'93.9			T5-b
		3S-GE				T5-b
	AW11	4A-GZE	'86.8~'89.9			T2-a
		4A-GE	'84.6~'89.9			T1-a

Vehicle Name	Model Type	Engine	Year	ECU Location	Note	Wiring Diagram	
CELICA	ST205	3S-GTE	'94.2~*	e		T5-b	
		3S-GE	'93.10~'97.11			T6-d	
	ST202 ST203	3S-FE	'96.6~*			M/T	T4-f
			'95.8~'96.5			A/T	T5-g
			'93.10~'95.7			M/T	T4-f
			'91.9~'93.9			A/T	T5-b
	ST185	3S-GTE	'89.10~'91.8				T5-b
			'89.10~'93.9				T5-a
	ST182	3S-GE	'89.10~'93.9				T5-a
	ST165	3S-GTE	'85.8~'89.9				T2-a
ST162	3S-GE	'85.8~'89.9			T2-a		
CURREN	ST206 ST207	3S-FE	3S-GE	'94.1~'98.7	e		T6-d
			'96.6~'98.7			M/T	T4-f
			'95.10~'96.5			A/T	T5-g
			'94.1~'95.9			M/T	T4-a
						W/A/T·TRC	T6-c
						W/O·A/T·TRC	T5-c
CARINA ED CORONA EXIV	ST202 ST203	3S-FE	3S-GE	'93.10~'98.4	e		T6-d
			'96.6~'98.4			M/T	T4-f
			'95.8~'96.5			A/T	T5-g
			'93.10~'95.7			M/T	T4-a
						W/A/T·TRC	T6-c
						W/O·A/T·TRC	T5-c
CALDINA	ST215W	3S-GTE	'97.8~*	d		T9-a	
	ST215G	3S-FE				T5-d	
	ST210G					T5-d	
	ST195G	3S-GE			'95.2~'97.7		T6-a
	ST195G ST191G	3S-FE	'96.1~'97.7			M/T	T4-f
			'94.2~'95.12			2WD·A/T	T5-h
			'92.11~'94.1			4WD·A/T	T5-g
						W·FF·TRC	T6-a
						W/O·FF·TRC	T5-e
						4WD·M/T	T4-b
	ST190G	4S-FE	'92.11~'97.7			4WD·A/T	T5-e
						FF·A/T	T6-e
						4WD·M/T	T4-b
						4WD·A/T	T5-e
COROLLA SPRINTER	AE111	4A-GE	'95.5~*	e		T5-b	
		4A-FE				T4-b	
		5A-FE				T4-b	
	AE101	4A-GE	'91.6~'95.4			M/T	T4-a
		4A-FE				A/T	T5-b
	AE92	4A-GE	'89.5~'91.5			M/T	T4-b
			'87.5~'89.4			A/T	T5-b
							T4-a
							T1-a

Vehicle Name	Model Type	Engine	Year	ECU Location	Note	Wiring Diagram	
COROLLA LEVIN SPRINTER TRUENO	AE111	4A-GE	'95.5~*	e		T5-b	
		4A-FE				T4-b	
		5A-FE				T4-b	
	AE101	4A-GZE	'91.6~'95.4			T5-b	
		4A-GE			M/T	T4-a	
		4A-FE			A/T	T5-b	
	AE92	4A-GZE	'89.5~'91.5			M/T	T4-b
			'89.5~'91.5			T5-b	
		4A-GE	'89.5~'91.5				T4-a
			'87.5~'89.4				T1-a
AE86	4A-GE	'83.5~'87.4	a		T1-c		
COROLLA CERES SPRINTER MARINO	AE101	4A-GE	'92.5~'95.4	e	M/T	T4-a	
		4A-FE			A/T	T5-b	
			M/T		T4-b		
COROLLA FX	AE101	4A-GE	'92.5~'95.4	e	A/T	T5-b	
		4A-FE			M/T	T4-a	
		A/T	T5-b				
		M/T	T4-b				
		A/T	T5-b				
AE92	4A-GE	'89.5~'92.4			T4-a		
		'87.5~'89.4			T1-a		
STARLET	EP91	4E-FTE	'95.12~*	d		T4-d	
		4E-FE				T3-b	
	EP82	4E-FTE	'89.12~'95.11	e	M/T	T3-a	
			'92.1~'95.11		A/T	T4-a	
			'89.12~'91.12			T3-a	
	EP71	4E-FE	'89.12~'95.11			T3-c	
		2E-TE	'86.1~'89.12			T1-b	
		2E-E			T1-b		
RAV4	SXA1#G	3S-FE	'97.9~*	e	M/T	T4-f	
	SXA11W	3S-GE				A/T	T5-g
	SXA10W		'96.8~*				T5-c
	SXA11G	3S-FE	'95.4~'97.8			M/T	T4-c
			'94.5~'97.8			A/T	T5-c
	SXA10G				M/T	T4-c	
			A/T	T5-c			

ECU Wiring Diagram (TOYOTA)

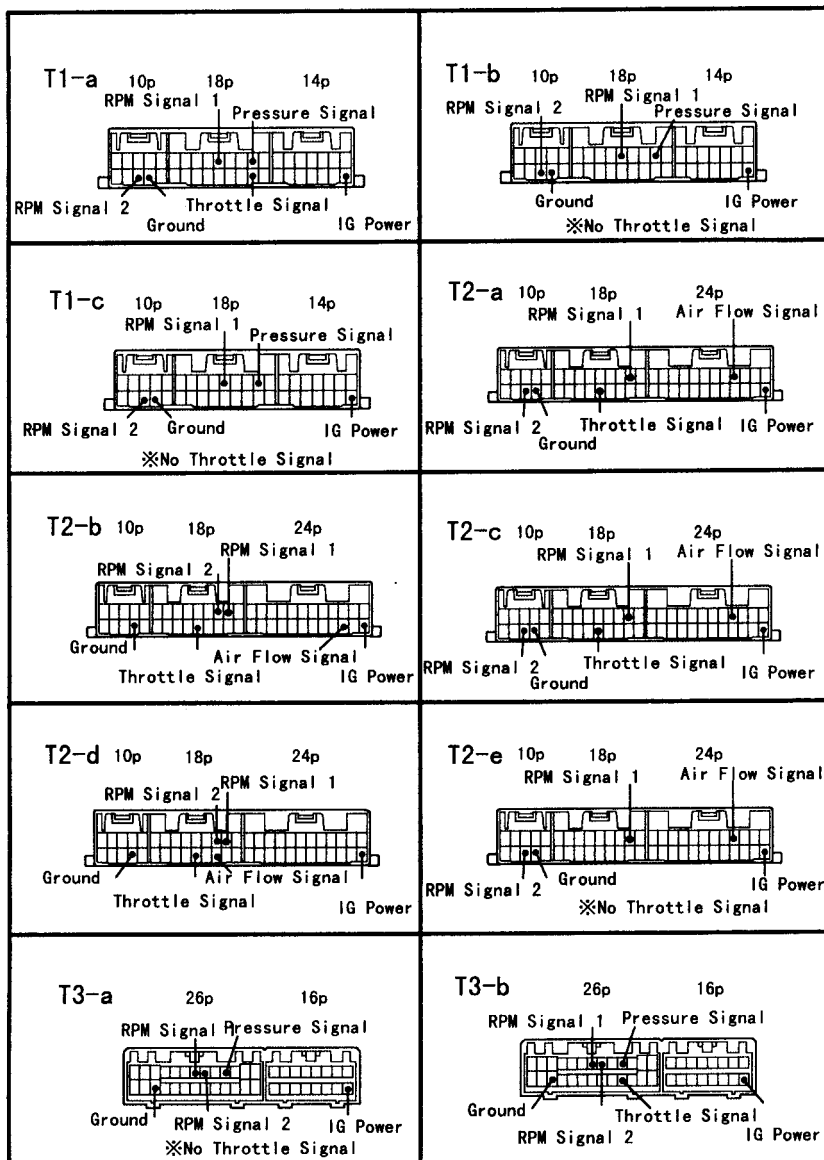

Regular Connection : RPM Signal 1

Plural Connection : RPM Signal 2

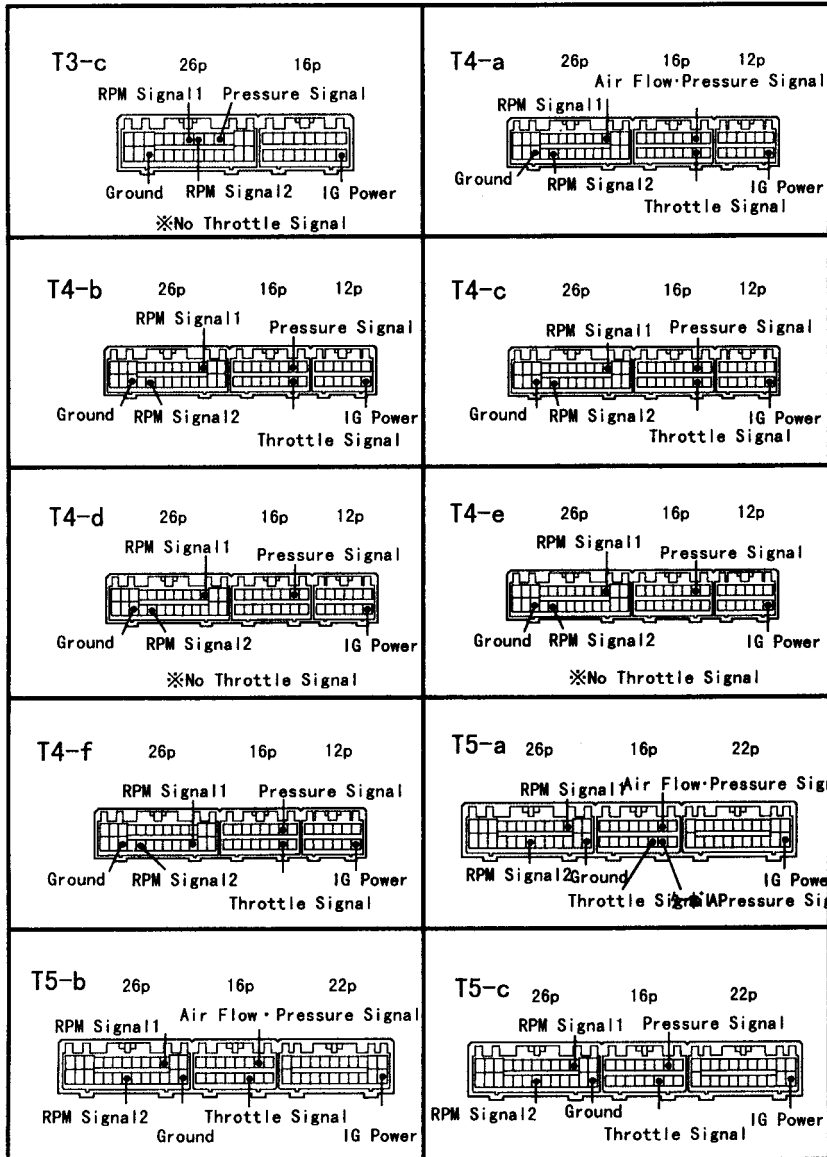

Regular Connection : RPM Signal1

Plural Connection : RPM Signal2

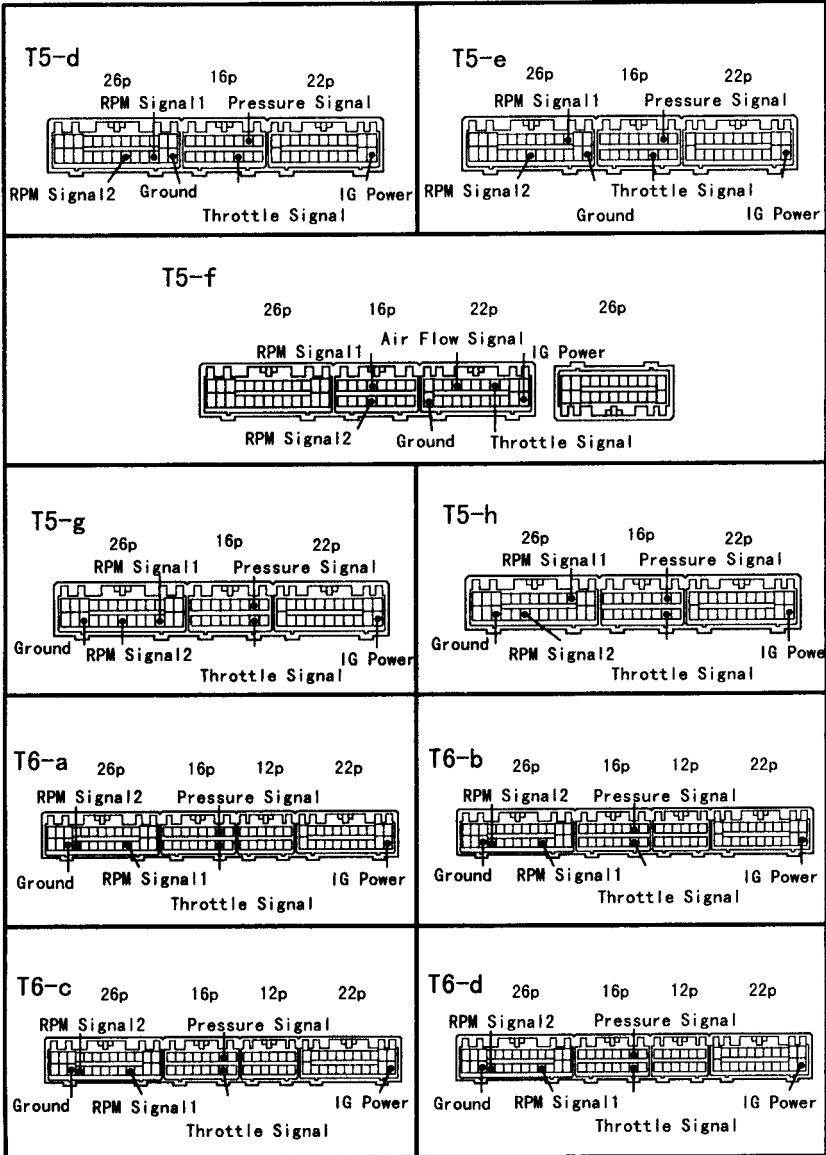

Regular Connection : RPM Signal1
 Plural Connection : RPM Signal2

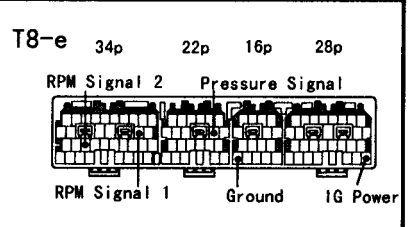
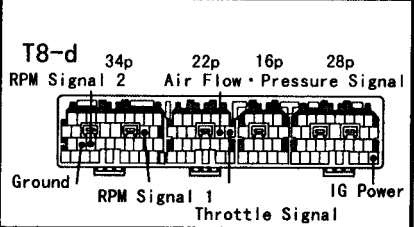
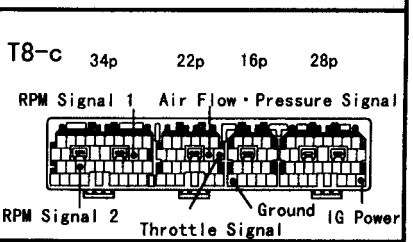
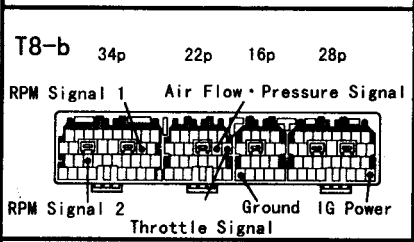
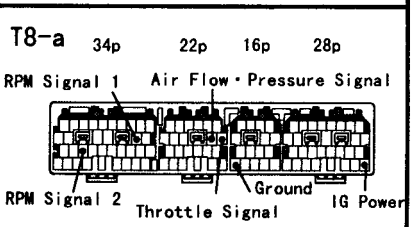
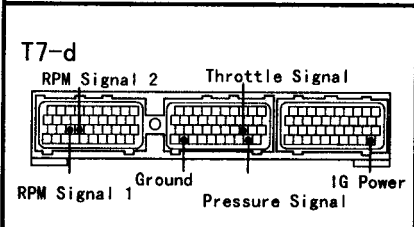
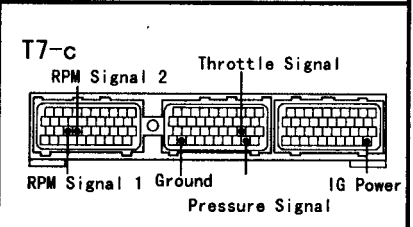
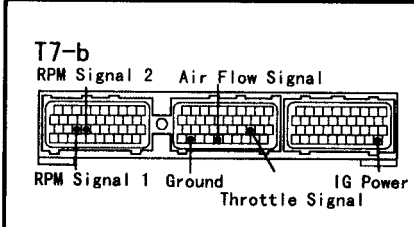
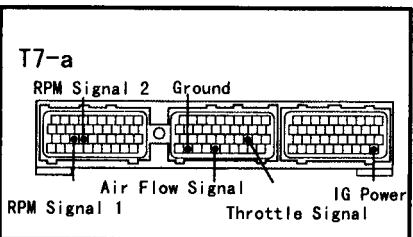
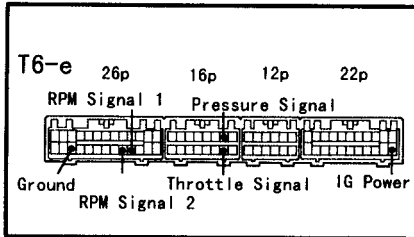

Regular Connection : RPM Signal 1
 Plural Connection : RPM Signal 2

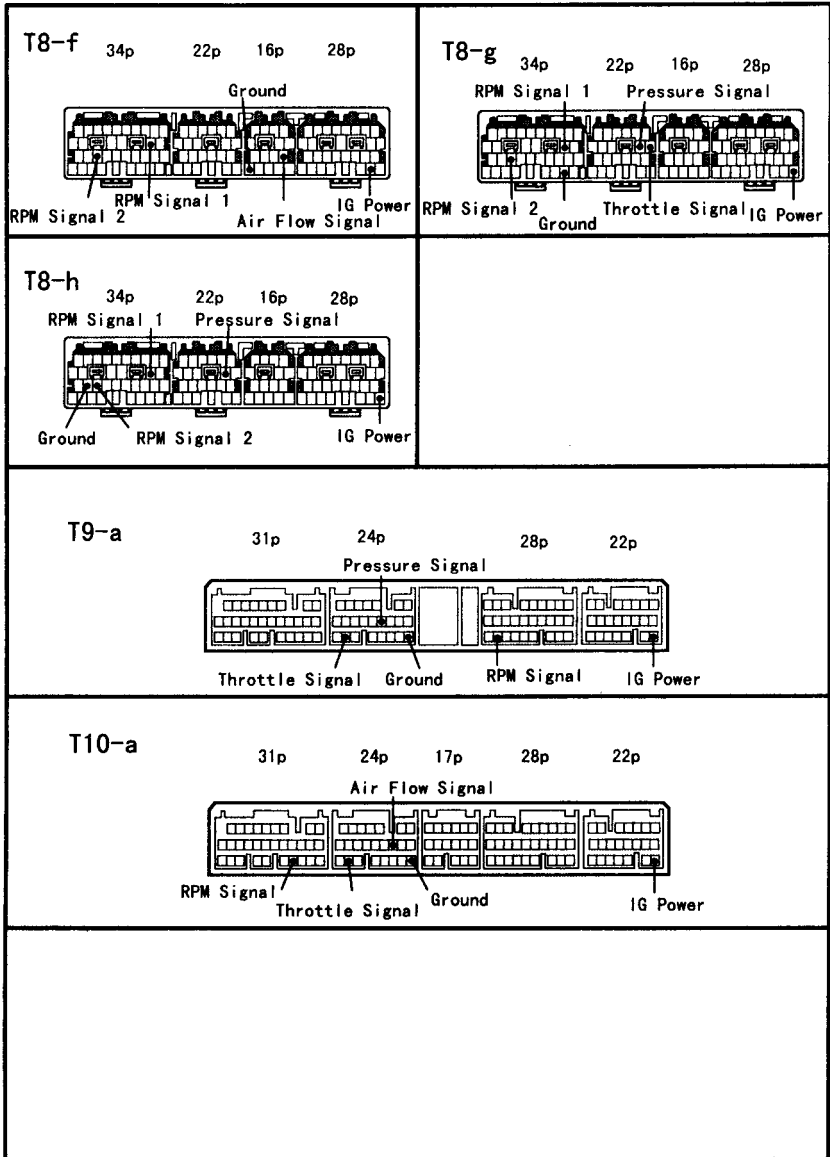

Regular Connection : RPM Signal 1

Plural Connection : RPM Signal 2

■ Vehicle Application Table (NISSAN)

Vehicle Name	Model Type	Engine	Year	ECU Location	Note	Wiring Diagram	
PRESIDENT	G50	VH45DE	'90.10~*	a		N4-a	
INFINITY Q45	G50	VH45DE	'89.11~'97.9	a		N4-a	
CIMA III	FGY33	VH41DE	'96.6~'98.9	a		N6-a	
	FHY33	VG30DET				N5-a	
CIMA II	FGY32	VH41DE	'91.8~'96.5	a		N4-a	
	FPY32	VG30DET	'93.9~'96.5			N4-d	
CIMA I	FPY31	VG30DET	'89.8~'91.7	a		N4-e	
		VG30DE					
		VG30DET	'88.1~'89.7			N2-a	
		VG30DE					
FAIRLADY Z	Z32	VG30DETT	'89.7~*	c		N4-a	
		VG30DE					
LEOPARD	Y33	VG30DET	'96.3~*	a		N5-a	
		VG30DE					
	UF31	VG30DET	'88.8~'92.5	a		N4-f	
		VG30DE					
GF31	VG20DET				N2-a		
LEOPARD J FERRY	JGBY32	VH41DE	'92.6~'96.2	a		N4-a	
	JPY32	VG30DE	'92.6~'96.2	a		N4-d	
GEDRIC GLORIA	Y33	VG30DET	'95.6~*	a		N5-a	
		VG30DE					
	Y32	VG30DET	'91.6~'95.5			N4-d	
		VG30DE					
	Y31	VG20DET	'89.6~'91.5			N4-e	
		VG20E					
CEFIRO	A32	VG30DE	'97.1~*	e		N6-c	
		VQ25DE					
		VG20DE				M/T	N4-a
						A/T	N6-c
		VG30DE					
		VQ25DE					
	VG20DE	'94.8~'96.12			N4-a		
	VG20DE						
A31	RB20DET	'88.9~'94.7	a		N4-a		
	RB25DE	'92.5~'94.7					
	RB20DE	'88.9~'94.7					
CEFIRO WAGON	W#A32	VG30DE	'97.1~*	e		N6-c	
	VQ25DE						
	VQ20DE						
LAUREL	C35	RB25DET	'97.6~*	a		N6-b	
		RB25DE					
		RB20DE					
	C34	RB25DET	'94.1~'97.5			N4-a	
		RB25DE	'93.1~'97.5				
		RB20DE					
	C33	RB20DET	'89.1~'92.12			N4-a	
		RB20DE					

Vehicle Name	Model Type	Engine	Year	ECU Location	Note	Wiring Diagram	
SKYLINE	R34	RB26DETT	'99.1~*	a		N4-b	
		RB25DET	'98.5~*			N6-c	
	R33	RB26DETT	'95.1~*			N4-b	
		RB25DET	'96.1~'98.4			N4-c	
		RB25DE					
		RB25DET	'93.8~'95.12			N4-a	
	R32	RB26DETT	'89.8~'94.12		a		N4-b
		RB25DE	'91.8~'93.7				
		RB20DET	'89.5~'93.7				N4-a
		RB20DE					
R31	RB20ET	'87.8~'89.5					
	RB20E			N1-a			
STAGEA	W#C34	RB25DET	'96.8~*	a			N6-c
		RB25DE					
STAGEA Autech Ver.	WGNC34	RB26DETT	'97.10~*				N4-b
BLUE BIRD	U14	SR20VE	'97.9~*			e	
		SR20DE	'96.1~*				
		SR18DE					
	U13	SR20DET	'91.9~'95.12				
		SR20DE					
	U12	SR18DE	'89.10~'91.8				
		SR20DET					
		SR20DE					
SILVIA	S15	CA18DET	'87.9~'89.9		N4-a		
		CA18DE					
	S14	SR20DET	'99.1~*	a		N3-a	
		SR20DE	'96.6~'98.12			N3-a	
PS13	SR20DE	'93.10~'96.5			N4-a		
	SR20DE	'93.10~*			N3-a		
S13	SR20DET	'91.1~'93.9			N3-b		
	SR20DE				N3-a		
180SX	RPS13	CA18DET	'88.5~'91.1			N4-a	
		CA18DE					
		SR20DET	'96.8~'98.12		N3-d		
	RS13	SR20DE	'91.1~'96.7		N3-b		
SR20DET		'89.3~'90.12		N4-a			
PULSAR	N15	CA18DET	'97.9~*	e	Excluding N1 Ver.	N3-a	
		SR16VE	'95.1~*				
	N14	SR18DE	'90.8~'94.12			N3-a	
		SR20DET					
PRIMERA	P11	SR18DE	'97.9~*	e		N3-a	
		SR20VE	'95.9~*				
		SR20DE					
	P10	SR18DE	'90.2~'95.8			N3-a	
		SR20DE	'92.9~'95.8				
		SR18DE					
PRIMERA WAGON	W#P11	SR20VE	'97.9~*	e		N3-a	
		SR20DE					
		SRI8DE	'97.9~*				

Vehicle Name	Model Type	Engine	Year	ECU Location	Note	Wiring Diagram
AVENEIR	W11	SR20DET	'98.8~*	e		N3-a
		SR20DE				
	W10	SR20DET	'95.8~'98.7			
		SR20DE	'90.5~'98.7			
		SR18DE	'93.1~'98.7			
SUNNY	B14	SR18DE	'94.1~'98.9	e		N3-a
	B13		'90.1~'93.12			
NX COUPE	B13	SR18DE	'90.1~'93.12	e		N3-a
MARCH	K11	CG13DE	'92.1~*	e		N3-c
		CG10DE				
CUBE	Z10	CG13DE	'98.2~*	c		N3-c
TERRANO	YD21	VG30E	'89.10~'95.8	f		N3-a

ECU Wiring Diagram (NISSAN)

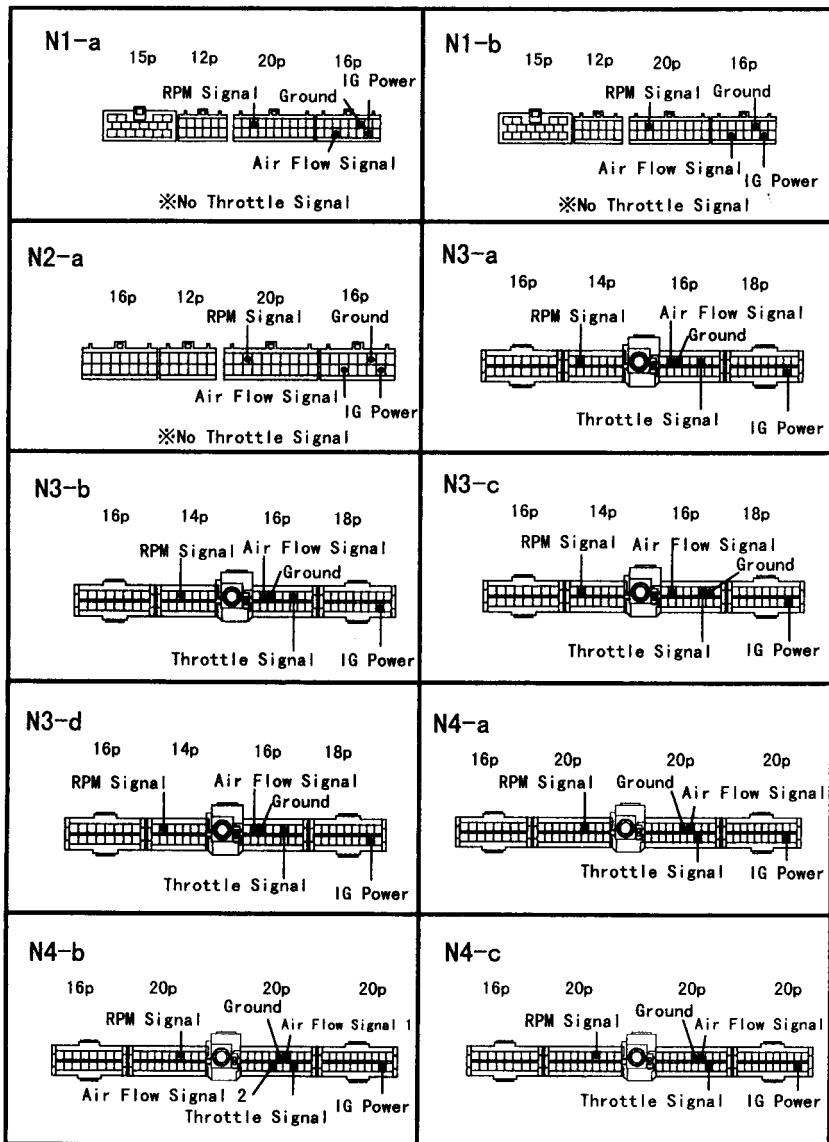

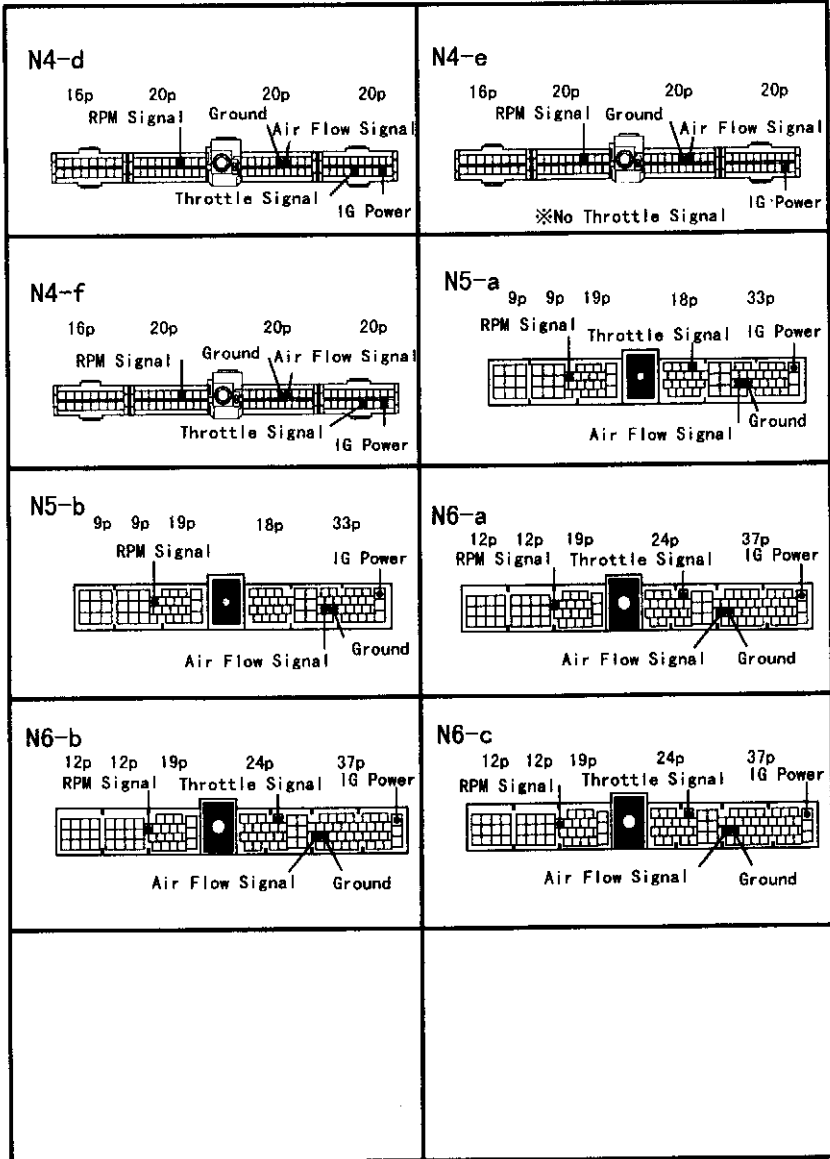

■ Vehicle Application Table (MITSUBISHI)

Vehicle Name	Model Type	Engine	Year	ECU Location	Note	Wiring Diagram
DIAMANTE	F36A	6G72	'95.1~*	e	MIVEC	M3-b
	F17A		'90.5~'94.12	a	DOHC	M5-a
GTO	Z16A	6G72	'90.10~*	e	DOHC	M2-a
FTO	DE3A	6A12	'94.10~*	b	MIVEC	M3-b
			'96.2~*			M3-b
	DE2A	4G93	'94.10~'96.1			M2-a
LEGNUM	EC5W	6A13	'96.8~*	e	DOHC	M3-a
GALANT	EC5A	6A13	'96.8~*	e		M3-a
	E84A	6A12	'92.5~'96.7		DOHC	M2-a
	E39A	4G63	'87.10~'92.4	b	DOHC	M1-a
ECLIPSE	D32A	4G63	'95.6~*	e		M3-a
	D27A		'89.11~'95.6			M1-a
LANCER	CK4A	4G92	'95.10~*	b	MIVEC	M3-b
	CM5A	4G93	'91.10~'95.9			M3-a
	CD5A					M2-a
	CP9A	4G63	'99.1~*			M3-a
	CN9A		'98.1~'98.12			
	CE9A		'96.8~'97.12			
	CD9A		'93.10~'96.7			M2-a
LIBERO	CD5W	4G93	'92.10~'93.9	b		M2-a
MIRAGE	CM5A	4G93	'92.5~*	b		M3-a
	CJ4A	4G92	'95.10~*		MIVEC	M3-b
	CA4A		'91.10~'95.9		MIVEC	M2-a
PAJERO	V25W	6G74	'93.7~*	a		M2-a
	V23W	6G72	'91.1~*			M1-a
RVR	N74W	4G64	'97.10~*	b		M3-a
	N73W	4G63			M/T	
	N71W	4G93			A/T	M5-a
	N61W					M3-a
	N23W	4G63			'92.10~'97.9	

ECU Wiring Diagram (MITSUBISHI)

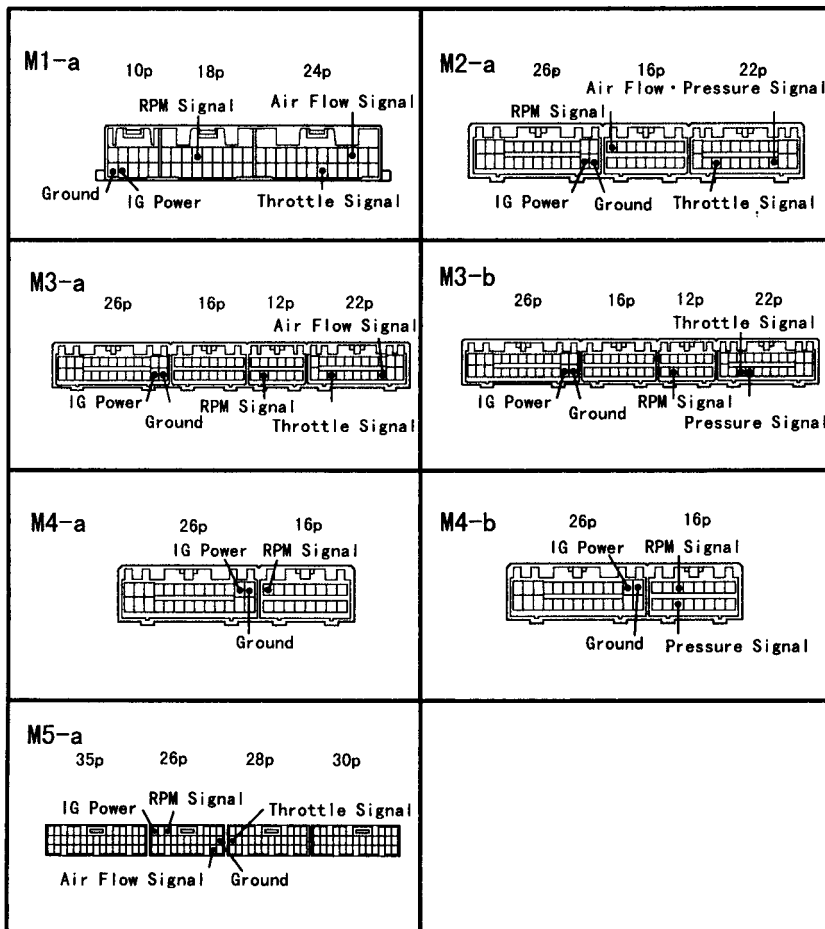

Vehicle Application Table (HONDA)

Vehicle Name	Model Type	Engine	Year	ECU Location	Note	Wiring Diagram
NSX	NA2	C32B	'97.2~*	n		H3-d
	NA1	C30A	'95.3~*			H3-d
			'90.9~'95.2			H3-a
LEGEND	KA9	C35A	'96.2~*	c		H3-b
	KA8	C32A	'90.12~'96.1			H3-a
	KA7		'90.10~'96.1			
INSPIRE	UA5	J32A	'98.10~*	e		H7-b
	UA4	J25A				
	UA2	G25A	'95.2~'98.9	c		H3-c
	UA1	G20A				
	CC2	G25A				
	CB5	G20A			'89.10~'91.12	
PRELUDE	BB6	H22A	'96.12~*	c		H6-a
	BB8					
	BB1		'91.9~'96.11		TRC付	H3-c
	BB4				TRC無	H2-a
ACCORD	CF3	F18B	'97.9~*	c		H7-a
	CF4	F20B				
	CD5	F22B	'93.9~'97.8			H2-a
	CD6	H22A				
ACCORD WAGON	CF6	F20B	'97.10~*	c		H7-a
	CE1	F22B	'94.3~'97.9	c		H2-a
	CB9	F22A	'91.3~'94.2			
INTEGRA (Including Spec.) '98	DC2 DB8	B18C	'95.9~*	a	M/T	H6-a
					A/T	H3-c
			'93.5~'95.8		M/T	H2-a
	DA6	B16A	'89.4~'93.5	c	A/T	H3-c
CIVIC	EK9	B16B	'98.9~*	a		H7-a
	EK4	B16A				H7-a
	EK3	D15B				H7-a
	EK9	B16B			'97.6~'98.8	
	EK4	B16A	'95.9~'98.8			H6-a
	EK3	D15B				
	EG6	B16A	'91.9~'95.8			H2-a
	EG4	D15B				
EF9	B16A	'89.9~'91.8	c		H1-a	
CR-X	EG2	B16A	'92.3~'95.10	a		H2-a
	EG1	D15B		b		
	EF8	B16A	'89.9~'92.2	c		H1-a
CR-V	RD1	B20B	'95.10~*	a		H3-c
ODYSSEY	RA3	F23A	'97.10~*	c		H7-a
	RA4					H7-a
	RA5				J30A	
	RA1	F22B	'94.10~'97.9			H2-a
	RA2					
S-MX	RH1	B20B	'96.11~*	e		H3-c
STEP WGN	RF1	B20B	'96.5~*	c		H3-c
	RF2					
LIFE	JA4	E07A	'97.4~*	g		H4-a
CAPA	GA4	P15A	'98.4~*	a		H5-a

ECU Wiring Diagram (HONDA)

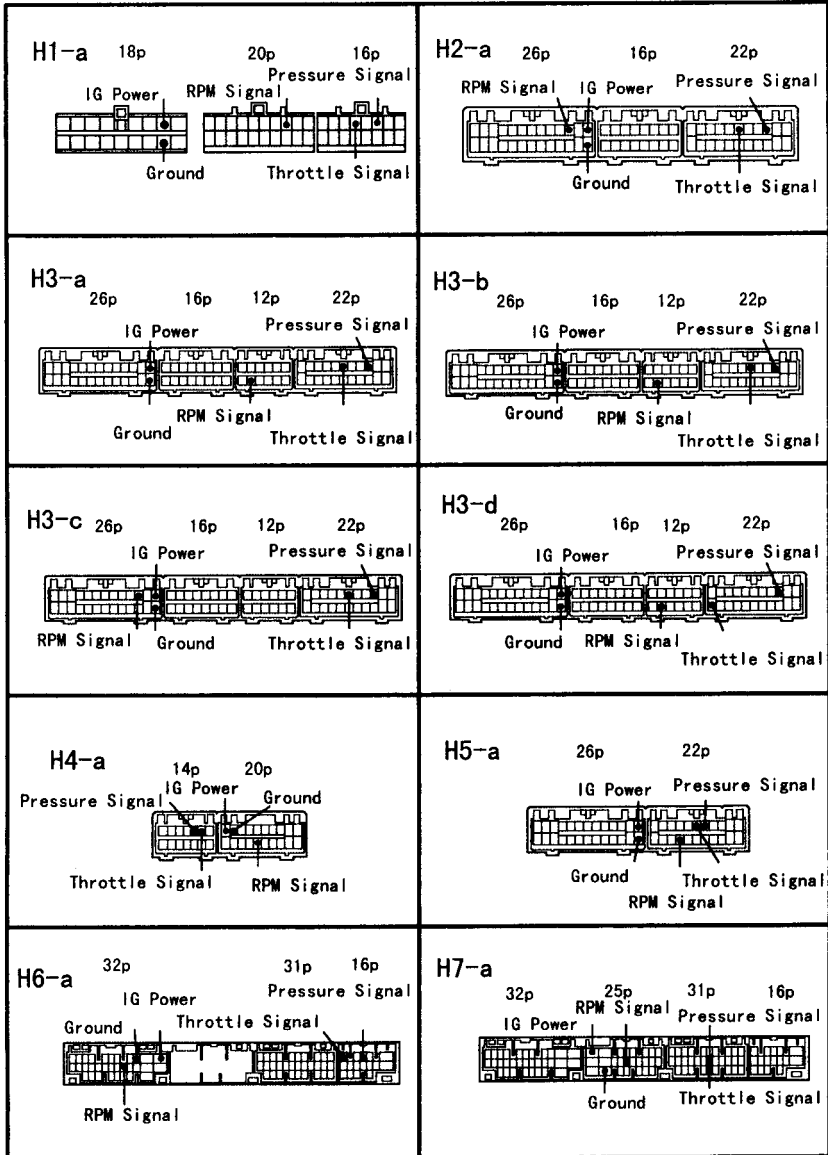

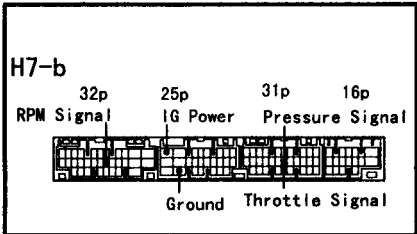

■ Vehicle Application Table (MAZDA)

Vehicle Name	Model Type	Engine	Year	ECU Location	Note	Wiring Diagram	
EUNOS COSMO	JC3S	20B-REW	'94.3~'95.8	c		Z3-a	
	JC3SE		'90.3~'94.3				
	JCES	13B-REW	'94.3~'95.8				
	JCESE		'90.3~'94.3				
RX-7	FD3S	13B-REW	'95.12~*	a		Z4-a	
			'91.12~'95.11			Z3-b	
	FC3S	13B	'88.9~'91.11	c		Z2-a	
			'85.19~'88.8			Z1-a	
ROADSTAR	NA8C	BP-ZE	'95.8~'97.12	c		Z6-a	
			'93.8~'95.7			Z5-a	
	NA6CE	B6-ZE	'89.9~'93.7			M/T	Z5-c
						A/T	Z5-a
FAMILIA	BG8Z	BP-ZET	'89.8~'94.3	e		Z5-b	
AZ-WAGON	MD21S	K6A T/C	'98.10~*	l		Z7-a	
	MD11S	F6A T/C				Z7-a	

ECU Wiring Diagram (MAZDA)

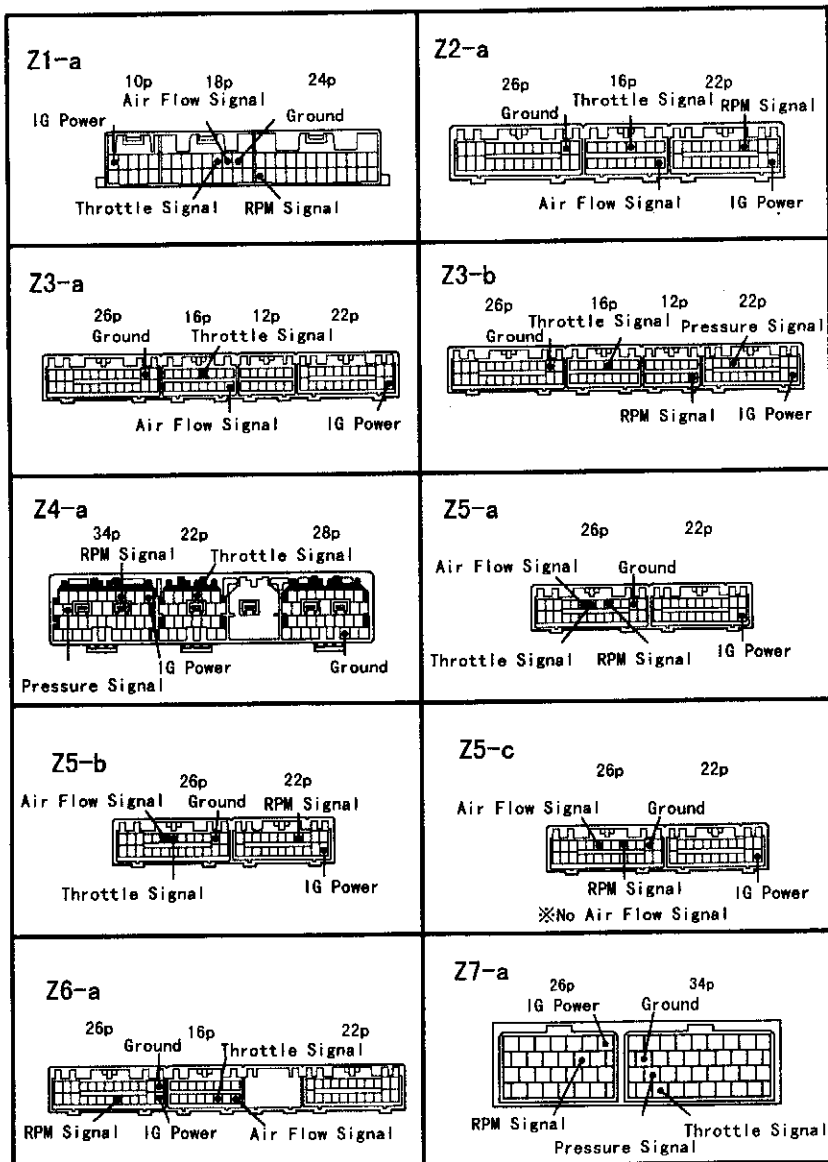

■ Vehicle Application Table (SUBARU)

Vehicle Name	Model Type	Engine	Year	ECU Location	Note	Wiring Diagram					
LEGACY	BH5	EJ208	'98.6~*			F4-a					
		EJ206									
	BD5 BG5	EJ20R	'96.6~'98.5	c		M/T	F1-b				
		EJ20H									
		EJ20D				'93.10~'96.5					
		EJ20H									
		EJ20D									
		EJ20H									
	BD9 BG9	EJ25D	'96.6~'98.5	c		F2-a					
			'94.10~'96.9				F1-a				
	BC5	EJ20G	'89.2~'93.9	h		F2-b					
BF5											
IMPREZA	GC8	EJ207	'98.9~*	c		F4-a					
	GF8	EJ205									
	GC8	EJ20K	'96.9~'98.8					F1-b			
	GF8										
	GC8								EJ20G	'92.11~'96.8	F2-b
	GF8									'96.9~'98.8	F1-b
		'93.10~'96.8	F2-b								
FORESTER	SF5	EJ205	'98.9~*	c		F4-a					
		EJ20G	'97.2~'98.8			F1-b					

■ ECU Wiring Diagram (SUBARU)

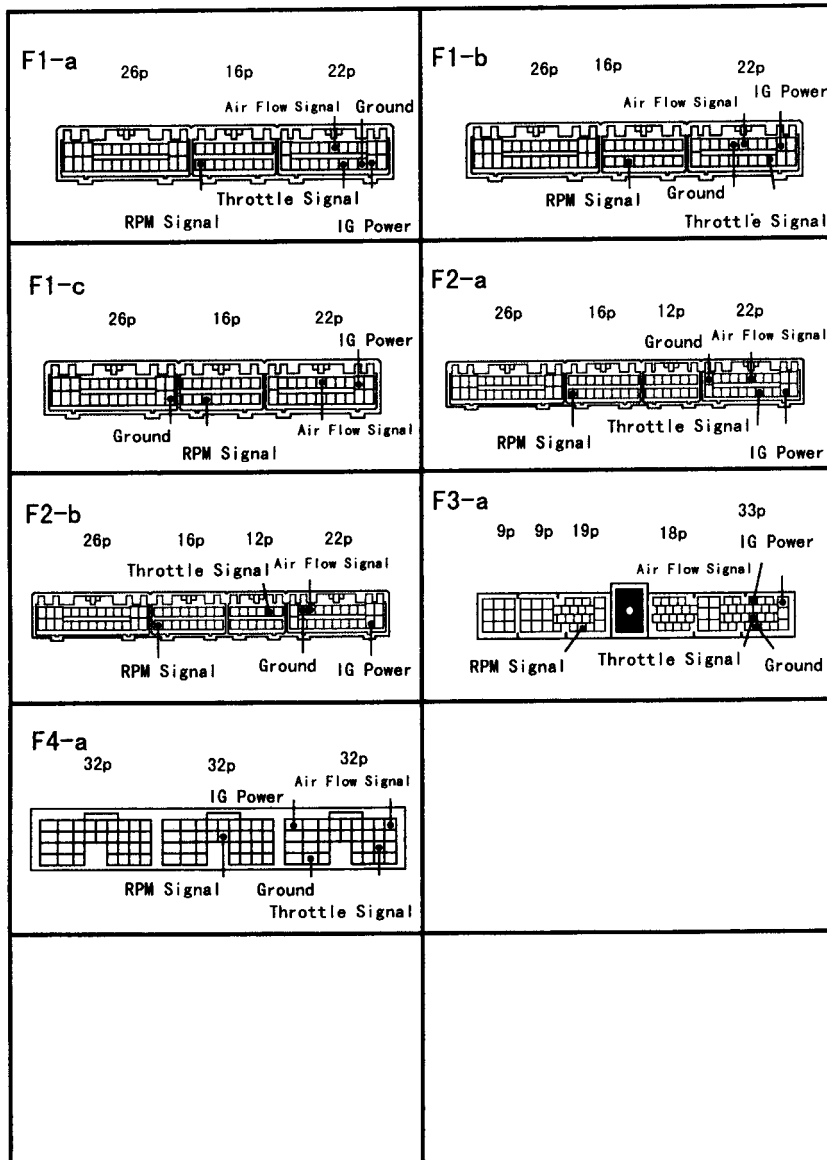

■ Vehicle Application Table (SUZUKI)

Vehicle Name	Model Type	Engine	Year	ECU Location	Note	Wiring Diagram
ALTO WORKS	HA22S	K6A T/C	'98.10~*	l	Excluding VVT	S6-a
	HA12S	F6A T/C				
	HA21S	K6A T/C	'94.11~'97.4	b		S3-a
	HB21S					
	HA11S				F6A T/C	M/T
HB11S	A/T	S4-a				
CAPUCHINO	EA21R	K6A	'95.5~'98.6	k		S5-a
	EA11R	F6A	'91.11~'95.10	b		S1-a
WAGON-R	MC21S	K6A T/C	'98.10~*	l		S6-a
	MC11S	F6A T/C				
	CT51S	K6A T/C	'97.4~'98.9	b		S5-a
	CV51S					
	CT21S				F6A T/C	'95.11~'98.9
	CV21S	'93.9~'95.10	A/T	S4-a		
	M/T		S1-a			
		A/T	S4-a			
WAGON-R WIDE	MA61S	K10A T/C	'97.2~*	b		S5-a
	MB61S					
KEI	HN21S	K6A T/C	'98.10~*	l		S6-a
	HN11S	F6A T/C				
GIMNY	JB23W	K6A T/C	'98.10~*	l		S6-a

ECU Wiring Diagram (SUZUKI)

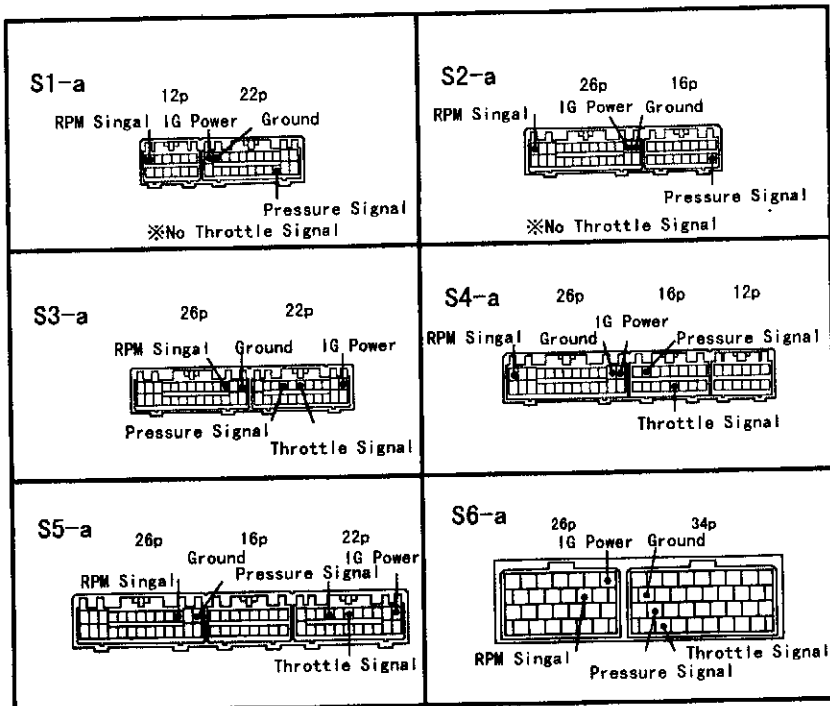

■ Vehicle Application Table (ISUZU)

Vehicle Name	Model Type	Engine	Year	ECU Location	Note	Wiring Diagram
BIG HORN	UBS25	6VD1	'91.12~*	e		L1-a

■ Vehicle Application Table (DAIHATSU)

Vehicle Name	Model Type	Engine	Year	ECU Location	Note	Wiring Diagram
MIRA TR-XX	L502S	JB-JL	'94.9~'98.9	d		D1-a
	L512S					
MOVE	L602S	JB-JL	'95.8~'98.9	d		D1-a

■ ECU Wiring Diagram (ISUZU)

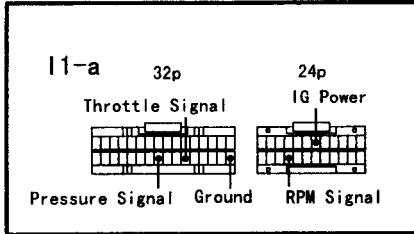

■ ECU Wiring Diagram (DAIHATSU)

