

FC-COMMANDER

HANDHELD CONSOLE for POWER-FC

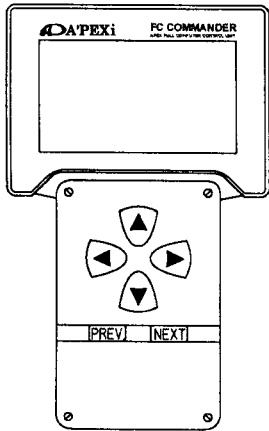

Instruction Manual

Thank you for purchasing this unit.

Please be sure to read this manual thoroughly to ensure proper use of this product. Please store this manual inside of the vehicle for reference. Please be sure to include this manual with the unit when selling.

Product Name	FC-COMMANDER
Product Code	415-Z001
Applicable Product	Refer to graph 1
Application	Refer to graph 1
Purpose	Confirm,modify setting data Monitor various parameters

This instruction manual is meant to be used in conjunction with the following products.

● Graph 1 Product Application Guide (POWER FC)

Product Code	Vehicle Name	Vehicle Type	Engine Type	Notes
414-Z002	RX-7	FD3S	13B-REW	'91/12 ~ '95/11 MT only



Chasing Our Dreams - A complete line of customized car and automotive parts developed with state of the art technology and new ideas. Our company is A'PEX which means the highest in quality.

Instruction Manual Code K7507-0120-02 '99. 9. 6 Ver. 3



■ Safety Precautions	1
● Glossary	1
● Display	1
▪ Warning	2
▪ Caution	3
■ To Begin	4
■ Part Names and Functions	5
● Parts List	5
● Product	6
■ Function and Setup	7
■ Installation	8
● FC-COMMANDER Connection	8
● FC-COMMANDER Mounting	8
● Checkpoints after Installation	9
● When the Ignition Key is ON...	9
■ menu 《Main Menu Selection》	10
① Main Menu Selection	10
■ monitor 《Data Display》	11
② Select Display Mode 【monitor】	12
②-a Select Display Mode 【monitor】→【1,2,4,8Channel】	13
● Display Data Contents	13
a.If selecting [1 Channel]	14
b.If selecting [2 Channel]~[8 Channel]	14
(1)Real time Display, Graph Display	15
(2)Peak Hold Function	15
(3)Data Hold Function	16
②-b Map Trace Mode 【monitor】→【MapTracer】	17
● Ghost Map Trace Mode	18

■ setting 《Setting Mode》19

③Setting Mode 【setting】	19
●Setting Parameter	19
③-a Changing Ignition Timing Map 【setting】→【IGL Map】	20
③-b Changing Ignition Timing Map 【setting】→【IGT Map】	20
③-c Changing Fuel Correction Map 【setting】→【Inj Map】	21
③-d Changing Pressure Sensor Characteristics【setting】→【PIM Volt】 ...	23
●Correcting Basic Fuel Injection 【setting】→【PIM Volt】	24
③-e Injector Pulse Timing Correction 【setting】→【injector】	25
③-f Boost Pressure Setting 【setting】→【Boost】	27
③-g Acceleration Enrichment Correction 【setting】→【Acceler.】	29
③-h Fuel/ Ignition Timing Test Correction 【setting】→【Ign/Inj】	30
③-i Water Temp Correction 【setting】→【Wtr Temp】 ...	31
③-j Changing Cranking Fuel Injection 【setting】→【Wtr Temp】	32
③-k RPM Setting 【setting】→【Rev/Idle】	33

■ etc. 《Other》34

④Other 【etc.】	34
④-a Program Version Display 【etc.】→【Prog.Version】	35
④-b Input Output Signal Check Display【etc.】→【Sensor/SW Check】 ...	35
④-c Original Function Setting 【etc.】→【Function Select】	36
④-d Display Brightness 【etc.】→【LCD/LED adjust】	38
④-e Initialize All Data 【etc.】→【All Data Init.】	38

***In Case of Malfunction*39**

***About the Warranty*39**

***Manual Information*39**

Safety Precautions

Please be sure to read the Safety Precautions.

Please keep this manual in a readily accessible location for future reference.

● Signal Words and Their Meanings

We have included warnings throughout this manual to protect both the user and others from harm and injury. These key words are called "Signal Words". Please carefully read the cautions before reading the rest of this manual.

● Explanation of Signal Words

DANGER

Failure to obey this warning will likely result in DEATH or severe injury to the user and third parties.

WARNING

Failure to obey this warning may cause DEATH or severe injury to the user and third parties.

CAUTION

Failure to obey this warning will likely result in injury to the user, product damage, or damage to the surrounding area

■ Safety Precautions (cont'd) -----

■ **WARNING**

● **Never install this product on a vehicle that is not listed in this manual**

We do not guarantee product operation on non-listed vehicle applications. Failure to follow instructions may cause unexpected accidents.

● **Discontinue use of this product immediately if there is smoke or a burning odor.**

Failure to do so may result in engine or vehicle fire. Please take the unit back to the place of purchase for further assistance.

● **Only use this product for the intended purposes listed within this manual.**

A'PEX is not responsible for any harm or accidents caused by the improper use of this product.

● **Never operate this unit while driving.**

Failure to do so may result in injury or accident.

● **Securely mount this unit away from any area that may affect driving.**

Failure to do so may result in injury or accident.

● **Be sure to disconnect the negative terminal of the battery before proceeding with installation.**

Failure to do so may result in vehicle fire, electrical shortage, electrical system damage, and product damage.

● **Be sure to securely hold the connector when disconnecting.**

Failure to do so may result in electrical shortage and damage the unit.

● **Always connect the wiring EXACTLY as shown in the instruction manual.**

Failure to do so may result in product failure and engine damage

● **Do not adjust the unit while driving. Obey all of the rules and regulations of the highway while driving**

Failure to do so may result in accidents.

■ Safety Precautions (cont'd)

■ CAUTION

● Installation should only be performed by an experienced installer.

Installation requires experience and skill. To the installer: Please install the product in a professional and functionally correct manner.

● Never disassemble, modify, or tamper with this unit.

Failure to do so may lead to electrical fire, vehicle fire, and engine damage.

● Do not drop or expose this unit to excessive shock.

This may damage the unit and cause damage to the engine.

● Keep this unit away from direct sunlight and water.

Failure to do so may cause product failure eventually leading to electrical fire, vehicle fire, and engine damage.

● Do not mount unit near direct water or high temperatures.

Failure to do so may result in electrical shortage and product failure. Product failure may lead to severe engine damage.

TO BEGIN

Thank you for purchasing the FC Commander. Please read these instructions to ensure proper product usage.

The FC-COMMANDER is an optional part for the POWER FC Fuel computer that allows modification of setting data, and monitoring of factory sensors.

~ Features ~

- ① Allows modifications to Fuel Injection and Ignition Setting Data.
- ② Allows monitoring of Factory Sensor Output Signals.
- ③ Can identify abnormal sensor signal when Engine Check Lamp is ON

This unit may be used in conjunction with the following part numbers

● Table 2 Application Chart (POWER FC)

Product Code	Vehicle Name	Vehicle Type	Engine Type	Notes	
414-Z002	RX-7	FD3S	13B-REW	'91/12 ~ '95/11	MT only



▪ CAUTION

- Be sure to check that your POWER FC is listed in the Application Chart
 - Do not use this product with any other unit not listed in the chart above.
- APEX is NOT responsible for any claim, damage, or mishap resulting from the improper use of this product.

Product Name	FC-COMMANDER
Product Code	415-Z001
Applicable Product	Above (table 2))
Applicable Vehicle	Above (table 2)
P u r p o s e	Modify and Confirm setting data

PART NAMES AND FUNCTIONS

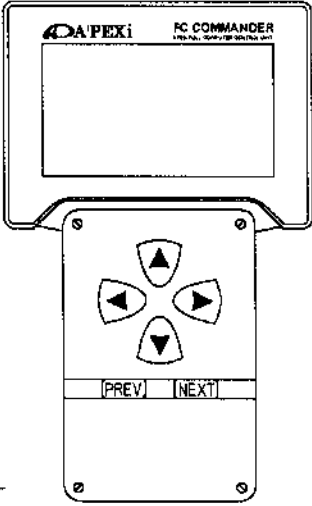
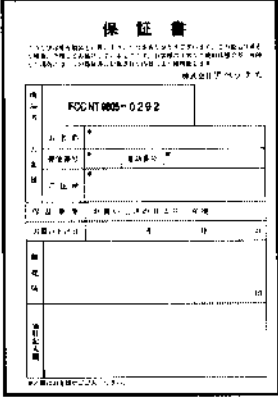
● Parts List

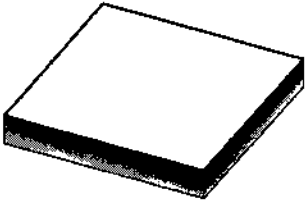
<p>1 . FC-COMMANDER</p>  <p>1pc</p>	<p>2 . Warranty Card</p>  <p>1pc</p>
<p>3 . Instruction Manual</p>  <p>※ This booklet</p> <p>1 pc</p>	<p>4 . Double Sided tape</p>  <p>2 pcs</p>

▪ CAUTION

- Be sure to check the contents of the box BEFORE attempting installation. Please contact your local dealer if there is any missing or broken parts. (Please contact your dealer of purchase for more information)
- Please contact your dealer of purchase for more instruction manuals or misc. parts.

■ PART NAMES AND FUNCTIONS

● Product

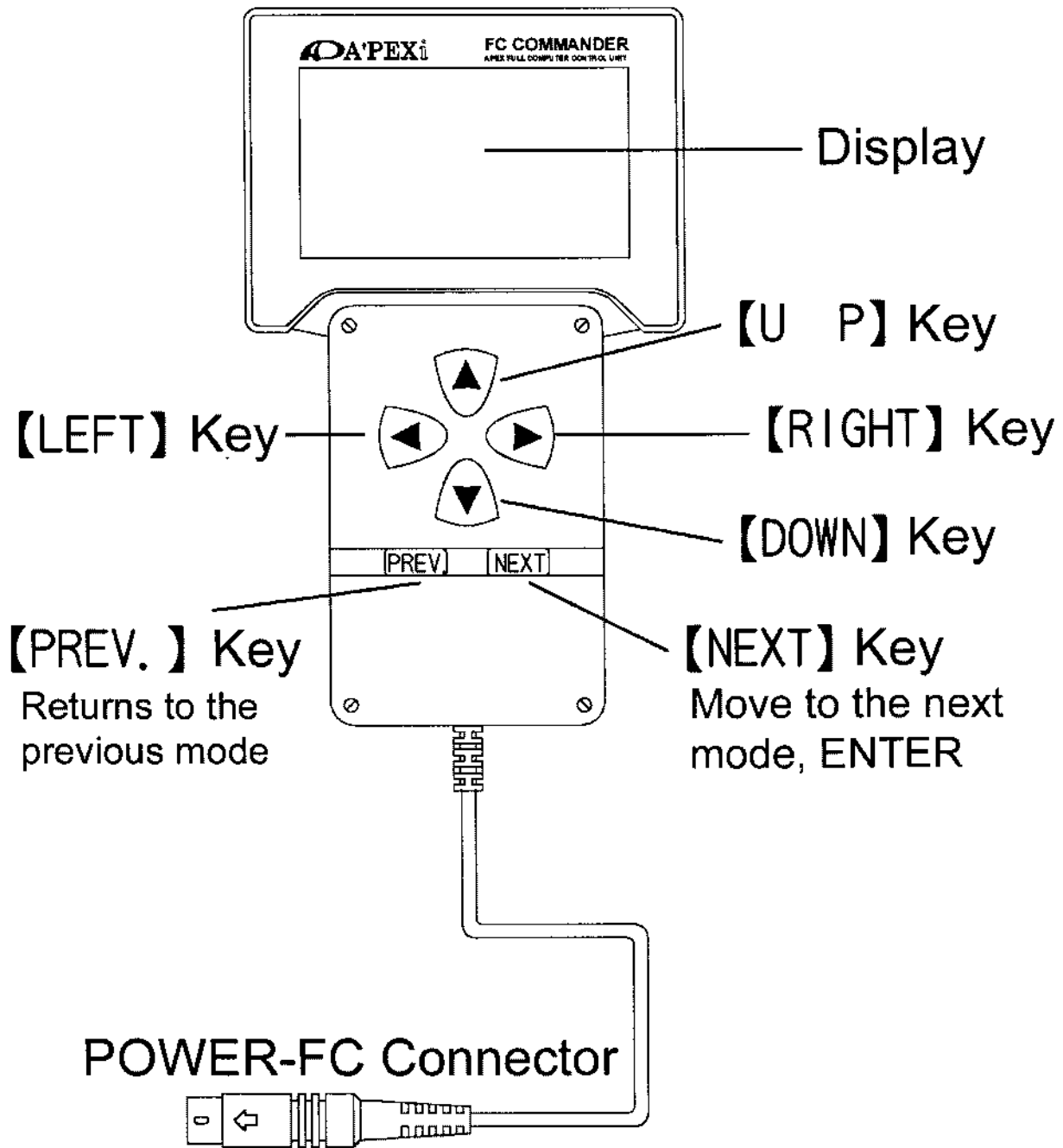

▪ **CAUTION**

● **ONLY** use the FC-COMMANDER with the properly specified application product and vehicle.
Failure to do so may result in engine and product damage.

Function and Setup

① Main Menu



In this screen,

- (1) monitor . . . Displays various data
- (2) setting . . . Change various settings
- (3) etc. . . . Displays and changes various other data

② Monitor Mode

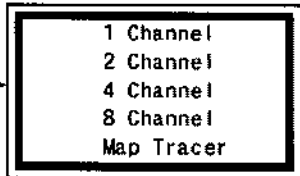

■ [1 Channel ~ 8 channel]

- InjDuty . . . Injector Duty cycle
- IgnT Ld . . . Ignition Timing (Leading)
- IgnT Tr . . . Ignition Timing (Trailing)
- Eng Rev . . . Engine RPM
- Speed . . . Vehicle Speed
- Boost . . . Boost
- Knock . . . Detonation Level
- WtrTemp . . . Water Temp
- AirTemp . . . Intake Air Temp
- BatVolt . . . Battery Voltage

■ [Map Tracer]

- ③-a IGL Map . . . Ignition Timing Map (Leading)
- ③-b IGT Map . . . Ignition Timing Map (Trailing)
- ③-c Inj Map . . . Fuel Correction Map
- ③-d PIM Volt . . . Press. Sensor Selection/Basic Fuel Injection Correction
- ③-e Injector . . . Injector Setting
- ③-f Boost . . . Boost Setting
- ③-g Acceler. . . Acceleration Enrichment Correction
- ③-h IGL/T, Fi . . . Ignition Timing/Fuel Test Correction
- ③-i Wtr Temp . . . Water Temp Corr./Cranking Fuel Correction
- ③-j Rev/Idle . . . RPM Setting

③ Setting Mode

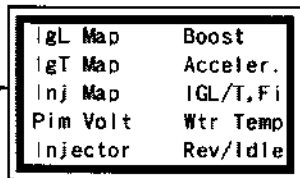

④ Etc. Mode

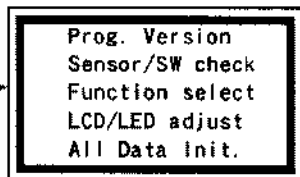

- ④-a Prog. Version . . . Program Version Display
- ④-b Sensor/SW check . . . Input Output Operation Display
- ④-c Function select . . . Original Function Setting
- ④-d LCD/LED adjust . . . LCD/LED Brightness Adjustment
- ④-e All Data Init. . . Initialize All Data

CAUTION

● When modifying the settings on the FC-COMMANDER, be sure to adjust according to the POWER FC settings and engine characteristics.

Improper settings from the FC-Commander can severely damage the engine.

● All setting modifications should be performed ONLY by an experienced tuner.

Improper settings WILL damage the engine. Apex does not assume responsibility for improper settings.

■ INSTALLATION

● FC-COMMANDER Installation

- ① *Remove the negative terminal (-) of the battery*

advice!

Disconnecting the negative terminal of the battery may erase memory settings of car audio, and navigation components. Please be sure to write down the settings before disconnecting the battery.



- ② *Connect the FC-COMMANDER (POWER-FC connector) to the POWER-FC (FC-COMMANDER connector)*

advice!

The FC-COMMANDER connector has an arrow on top of it. Face the arrow on towards the top and securely fasten the two connectors together.

● FC-COMMANDER Mounting Procedures

- ① *Mount the FC-COMMANDER in a location that does not interfere with normal driving by using the double sided tape.*



- ② *Check to make sure that the POWER FC connector has been securely connected.*



- ③ *Reconnect the negative(-) terminal of the battery.*

▪ CAUTION

- **Be sure to mount the FC-COMMANDER so that it does not interfere with normal driving.**

Interference may be the cause of accidents.

- **Keep the FC-COMMANDER away from direct sunlight and water.**

Direct sunlight and water will cause improper operation of the unit.

- **Be sure to mount the FC-COMMANDER away from any moving parts.**

Moving parts may sever or cut the harness thereby causing malfunction. The FC-COMMANDER and POWER-FC may both malfunction causing severe engine damage.

● Checkpoints After Installation

Please check the following points after installation.

- Has the POWER-FC connector been securely connected?
- Is there any excessive strain on the POWER-FC harness?
- Has the FC-COMMANDER been securely mounted?
- Has the Negative (-) terminal of the battery been properly reconnected?

● When the IGNITION KEY is ON...

Please check the following points when the IGNITION KEY is ON.

- Does the FC-COMMANDER properly display data?

(The LCD screen may turn black under hot conditions. The screen will return to normal once the temperature cools down.)

If the display does not function properly, please see your dealer of purchase for service.

- Is there any unusual sound or smell coming from the FC-COMMANDER?

If there is any unusual odor or sound coming from the FC COMMANDER, please stop use of the product immediately and return the product to the dealer of purchase.

- Is the Exhaust Temp Warning Indicator ON?

The POWER-FC has a built in diagnostic system that will illuminate the Exhaust Temp Warning indicator if there is any thing abnormal with a sensor. Please check the abnormal sensor with the FC-COMMANDER. Please repair or replace the damaged sensor immediately.

■ menu 《Main Menu Selection》 -----

The FC-COMMANDER allows the various data in the POWER-FC to be modified according to performance needs. The modified data is stored within the POWER-FC and remains in the memory until the INITIALIZE (All Data Init.)function is performed. Removing the ignition key or battery terminal will NOT affect the memory data.

① Main Menu Selection

The basic menu for the FC-COMMANDER

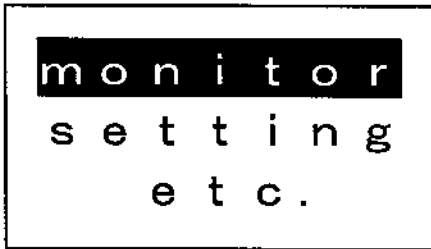

Main Menu

① 《Selection》

【▲】 up key / 【▼】 down key

Use these keys to select.

Selected parameter will illuminate.

① 《Enter》

【next】 key

Use this key to select.

The screen will change to desired menu.

<i>【monitor】 is</i>	<i>·P11</i>
Monitors various input/output signals	
<i>【setting】 is</i>	<i>·P19</i>
Allows Setting Data to be changed by the user	
<i>【 e t c 】 is</i>	<i>·P34</i>
Original Function Setting and various Sensor Checks	

▪ CAUTION

- Never operate this unit while driving.

Failure to do so may lead to accidents.

■ monitor 《Select Display Mode》 >-----

② Select Display Mode 【monitor】

Selecting 【monitor】 on the Main Menu will activate the Display Mode

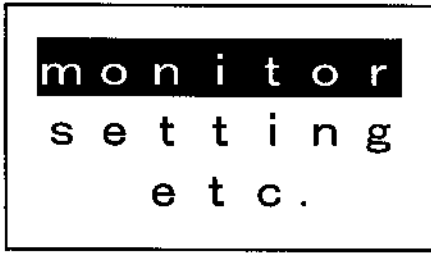

Main Menu

① 《Monitor Selection》
 【▲】 up key / 【▼】 down key
 Use these keys to select Monitor

② 《Monitor Entry》
 【next】 key
 Use this key to select
 The screen will change to desired menu.

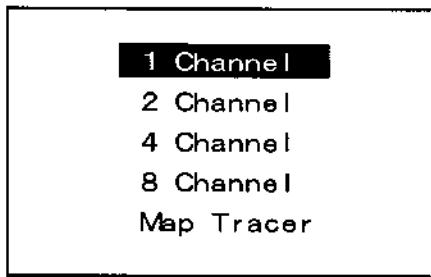

③ 《Display Method Selection》
 【▲】 up key / 【▼】 down key
 Use these keys to select
 The screen will change to desired menu.

④ 《Display Method Entry》
 【next】 key
 Use this key to select
 The screen will change to desired menu.

● Data Display P13

- Selecting 【 1 Channel 】 . . . will display 1 parameter of data
- Selecting 【 2 Channel 】 . . . will display 2 parameters of data
- Selecting 【 4 Channel 】 . . . will display 4 parameters of data
- Selecting 【 8 Channel 】 . . . will display 8 parameters of data

(Function)

(1)Real Time Display ← switch → Graph Display P15

(2)Peak Hold Function P15

(3)Data Hold Function P16

advice!!

There is no Peak Hold function in the Graph Display mode. Please refer to the corresponding pages for further information.

● Map Tracer P17

Selecting 【 M a p T r a c e r 】 . . will activate Map Trace Mode

(Function)

a. Real Time Display ← switch → Ghost Map Trace . . . P18

b. Data Hold Function P18

c. Display Clear P18

■ monitor 《Data Display》

②-a Select Display Mode [monitor] → [1,2,4,8Channel]

Select display parameters after choosing display channels.

The user can select from channels 1,2,4,8 and choose parameters from the list below.

● Display Data Information

1. InjDuty . . . Injector Duty Cycle
2. IgnT Ld . . . Ignition Timing (Leading)
3. IgnT Tr . . . Ignition Timing (Trailing)
4. Eng Rev . . . Engine RPM
5. Speed . . . Vehicle Speed
6. Boost . . . Intake Manifold Boost Pressure
7. Knock . . . Detonation Level (Knock)
8. WtrTemp . . . Water Temperature
9. AirTemp . . . Intake Air temperature
10. BatVolt . . . Battery Voltage

advice!

There is no value to the Knock level. Please use it as a reference when tuning.

Usually it is in Bar Graph display, but peak hold will only show in numerical format.

Please be aware that "0" may not be the only value when the vehicle is not detonating.

Please note that there is no knock retard system within the PowerFC.

■ monitor 《Data Display》

a. If selecting [1 Channel]

InjDuty	Boost
IgnT Ld	Knock
1 IgnT Tr	WtrTemp
Eng Rev	AirTemp
Speed	BatVolt

① 《Display Parameter Selection》

【▲】 up key / 【▼】 down key

Use these keys to select

The selected parameter will illuminate and the corresponding channel number will appear beside the parameter.

② 《Display Parameter Entry》

【NEXT】 key

Use this key to enter

the selected parameter will display

Please refer to the next page for display screen functions.

b. If selecting [2 Channel] ~ [8 Channel]

1 InjDuty	Boost
2 IgnT Ld	Knock
IgnT Tr	WtrTemp
Eng Rev	AirTemp
Speed	BatVolt

① 《Channel Selection》

【▲】 up key / 【▼】 down key

Use these keys to select

The selected channel will illuminate

② 《Channel Entry》

【▶】 right key

Use this key to select channel

The selected channel parameter will illuminate.

1 InjDuty	Boost
2 IgnT Ld	Knock
IgnT Tr	WtrTemp
Eng Rev	AirTemp
Speed	BatVolt

③ 《Display Parameter Selection》

【▲】 up key / 【▼】 down key

Use this key to select

The parameter will illuminate

advice !

Previously selected channels cannot be selected again.

④ 《Display Parameter Entry》

【NEXT】 key

Use this key to enter

This will activate display of desired parameters.

Please refer to next page for display screen functions.

■ monitor 《Data Display》

(1) Real Time Display, Graph Display

FC-COMMANDER can show the data from ②-b in real time values or graph modes.

【NEXT】 key Numerical Display ↔ Graph Display switch

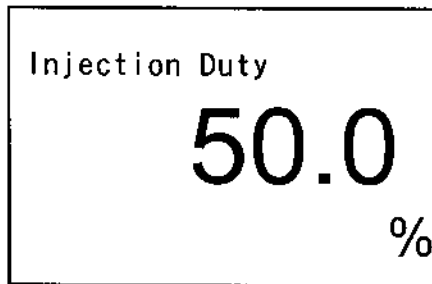

real time display

【NEXT】 key

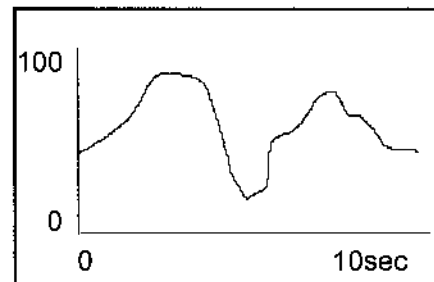
 switch



graph display

During Numerical Value Display . . .

(2) Peak Hold Function

The Peak Hold Function can be activated during Real Time Display.

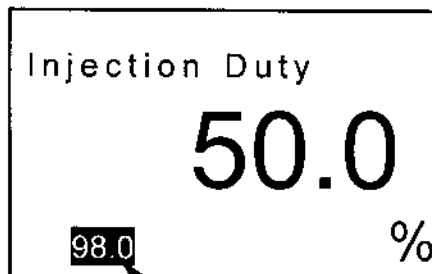

Peak Hold Value

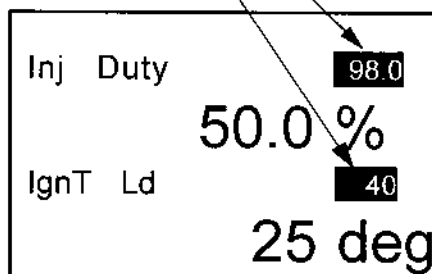

① 《Setting Peak Hold》

※ During Real Time Display

【▲】 up key

Use this key to select Peak Hold

The value will illuminate

② 《Peak Hold Value Reset》

※ During Peak Hold

【▶】 right key

Use this key to reset Peak Hold value

③ 《Peak Hold Release》

【▼】 down key

Use this key to release Peak Hold function

advice!

The Peak Hold value will only be updated while in the Real time or Graph Mode. Peak Hold values will NOT be updated in the Setting Mode, Map Tracer Mode, and Menu Modes.

■ monitor 《Data Display》 -----

During Numerical Value Display and Graph Display . . .

⑤ Data Hold Function -----

HOLD Function allows the current data in Real Time Mode or Graph Mode to be frozen.

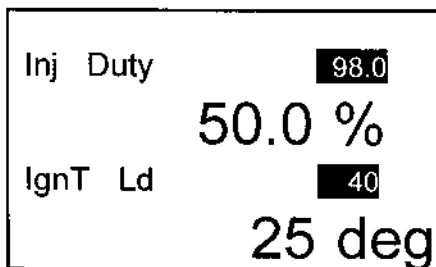

【 ← 】 left key

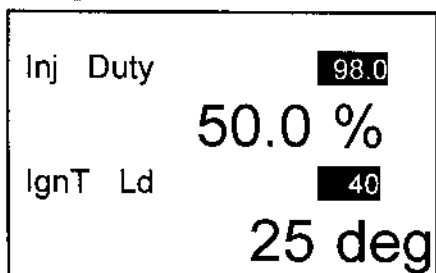

① 《Data Hold Setting》

※ During Real Time Display, also h Graph Display

【 ← 】 left key

Use this key to HOLD

② 《Data Hold Release》

※ During Data Hold

【 ← 】 left key

Use this key to release data hold.

■ monitor 《Map Trace Mode》

②-b Map Trace Mode 【monitor】 → 【MapTracer】

Fuel and Ignition Timing are displayed on two 20x20 maps showing Engine RPM and Load.

This mode allows the user to see exactly what part of the map is being read. The black area of the map is the portion that is being read. When changing the fuel and ignition maps in the setting mode, this trace mode can be used to identify used positions.

● Normal Display Mode

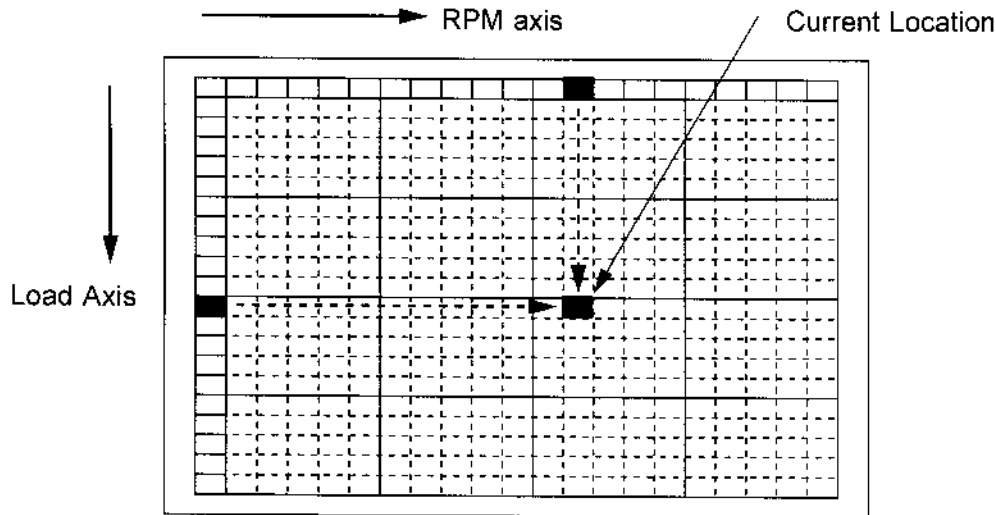

----▶ These arrows are for reference and will not appear on screen

■ monitor 《Map Trace Mode》

● Ghost Map Trace Function

The Ghost Map Trace Function will black out all used portions of the map during a specific session.

【NEXT】 key Ghost Map Trace Mode ←→ Normal display Mode switch

《Ghost Map Display Data Hold》

By using this function right after a run, tuning can be performed more efficiently by freezing the Ghost Map Trace data. This allows the user to confirm the relevant data to be modified.

※ During Ghost Map Trace Mode

【◀】 left key Ghost Map Trace Hold

Pushing the 【◀】 left key again will release this function

《Ghost Map Trace Clear》

【▶】 right key Ghost Map Trace Clear

If the Ghost Map Trace is cleared while in HOLD mode, the map tracer will not appear on the screen. Please press the 【◀】 left key to release the DATA HOLD function.

● Ghost Map Trace Mode

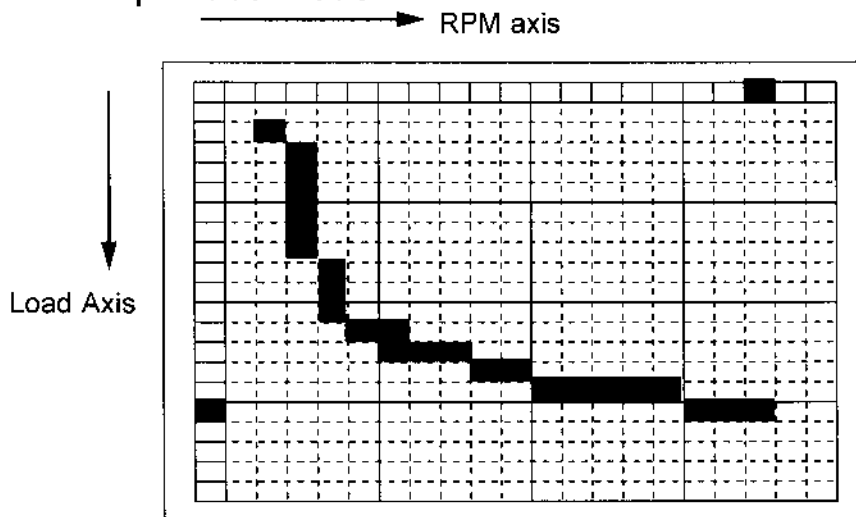

※ This shows an increase in load as the RPM rises.

advice!

Using this mode will allow the user to identify exactly what portion of the map is being used. This is extremely useful when tuning.

■ setting 《Setting Mode》

③ Setting Mode 【setting】

Selecting 【setting】 in the Main Menu will activate the Setting Mode

IGL Map	Boost
IGT Map	Acceler.
Inj Map	IGL/T, Fi
PIM Volt	Wtr Temp
Injector	Rev/Idle

```

m o n i t o r
s e t t i n g
e t c .
  
```

① 《Setting Parameter Selection》

【▲】 up key / 【▼】 down key

Use this key to select desired setting parameter
The selected parameter will illuminate.

② 《Setting Parameter Entry》

【NEXT】 key

Use this key to Enter
The selected parameter will appear

③ 《Ending Setting Parameter》

【PREV.】 key

Use this key to exit this menu
After the setting parameter selection, the screen
will go to the setting parameter selection menu.
After the setting parameter selection menu
The screen will go to the main menu.

※ 【PREV.】 key returns to the previous menu.

● Setting Parameter

③-a	[IGL Map]	<i>Changing Ignition Timing (Leading)</i>P20
③-b	[IGT Map]	<i>Changing Ignition Timing (Trailing)</i>P20
③-c	[Inj Map]	<i>Changing Fuel Correction Map</i>P21
③-d	[PIM Volt]	<i>Changing Press. Sensor and Basic Injection Correction</i>	P23
③-e	[Injector]	<i>Injector Pulse Timing Correction</i>P25
③-f	[Boost]	<i>Boost Setting</i>P27
③-g	[Acceler.]	<i>Changing Acceleration Enrichment Settings</i>P29
③-g	[IGL/T, Fi]	<i>Test Correction for Ignition timing and Fuel</i>P30
③-h	[Wtr Temp]	<i>Water Temp Corrcetion and Cranking Fuel Injection</i> P31
③-i	[Rev/Idle]	<i>RPM Setting</i> P33

■ setting 《Ignition Timing Map》

③-a Changing Ignition Timing Map **【setting】** → **【IGL Map】**

③-b Changing Ignition Timing Map **【setting】** → **【IGT Map】**

This allows the 20x20 ignition timing map to be modified with desired values. Although the FC-COMMANDER can only display a 5 × 5 portion of the map at once, the entire map can be adjusted by scrolling throughout the map.

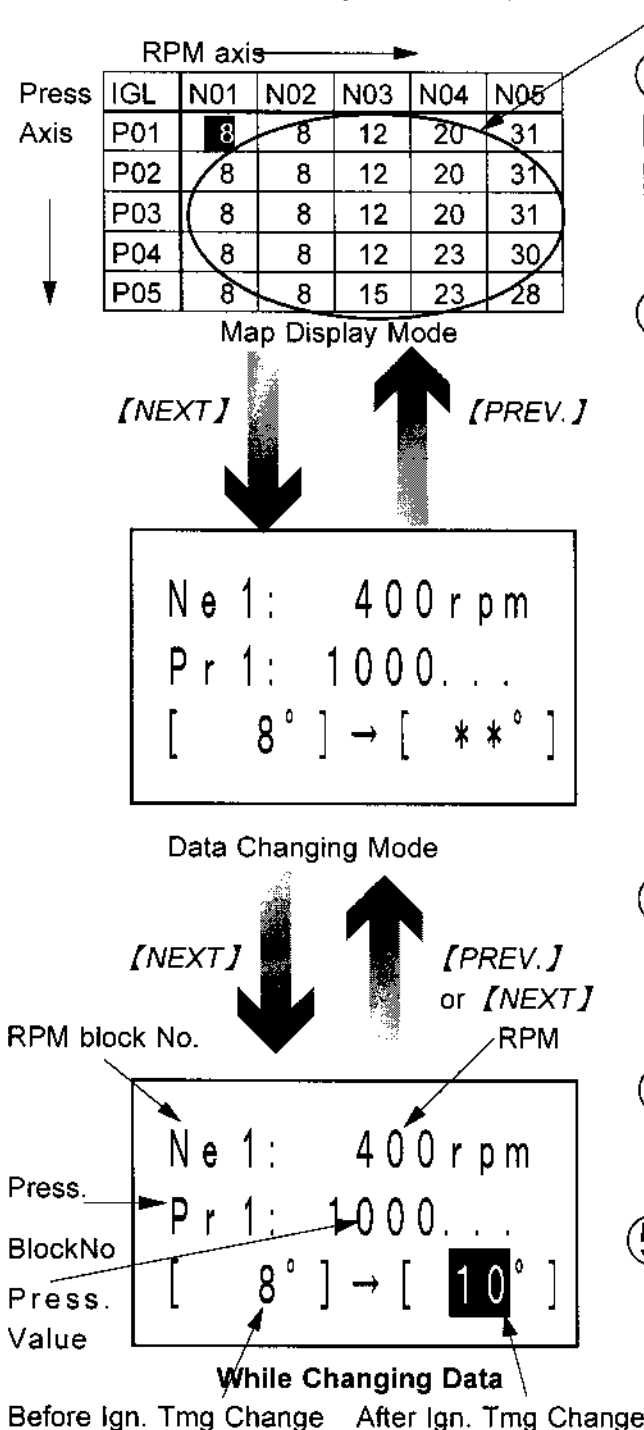

Ignition Timing

① 《Map Display Mode》

【▲】 up key / 【▼】 down key

【◀】 left key / 【▶】 right key

Use these keys to select

The selected block will illuminate

② 《Data Changing Mode》

【NEXT】 key

This will activate Data Changing Mode

The 【PREV.】 key will return to the setting menu mode.

advice!

Even in this mode,

【▲】 up key / 【▼】 down key

【◀】 left key / 【▶】 right key

will allow movement throughout the map.

③ 《Data Selection》

【NEXT】 key

This will allow the selected data to be changed

④ 《Data Changing》

【▲】 up key / 【▼】 down key

Use these keys to change ignition timing

⑤ 《Data Entry》

【NEXT】 key

Use this key to enter data

The 【PREV.】 key will return to the data changing mode without changing any data.

● What is a Pressure Value?

If the press. value is [20000], it is equal to 2.0 kg/cm² of absolute pressure. Atmospheric press. is about [10000] of pressure value.]

■ setting 《Fuel Correction Map》

③-c Changing Fuel Correction Map 【setting】 → 【Inj Map】

This will change the Fuel Correction Map. The map uses the same 20 x 20 size as the Ignition Timing Map. The Fuel Correction Value uses the ideal air fuel ratio of approx. 14.57 as 100%. If the value gets larger, the fuel mixture gets richer, if the value gets smaller, the mixture gets leaner.

● About the Basic Injection Map...

Pressure Sensor controlled vehicles do not use air flow volume to determine Fuel Injection Amounts. This is why a Basic Injection map exists aside from the Fuel Correction Map. The Basic Fuel Injection Map is a Load and RPM based map designed to achieve the ideal 14.57 air fuel ratio. However, on heavily modified engines (turbo upgrade, cam upgrade) it becomes necessary to change the Basic Fuel Injection map as well. The FC-COMMANDER does not allow direct modification to the Basic fuel Injection Map, but allows modification of the RPM and pressure sensor voltages by 5 points each.

Please refer to P24(Basic Fuel Injection Correction) for further information.

The Basic Fuel Injection Map can only be changed through authorized APEX Power Excel Tuning shops.

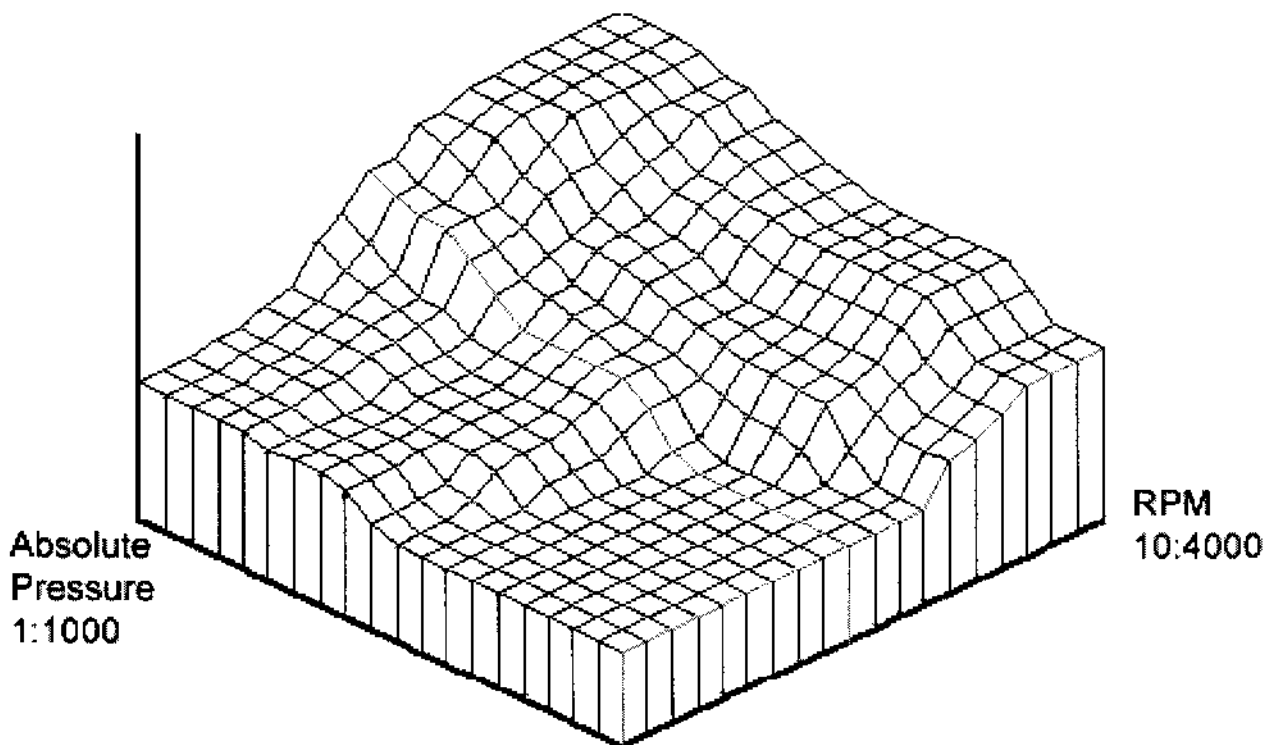

■ setting 《Fuel Correction Map》

RPM Axis →

Press Axis ↓	Inj	N01	N02	N03	N04	N05
	P01	121	121	115	106	106
	P02	121	121	115	106	106
	P03	121	121	115	106	106
	P04	121	121	115	106	106
	P05	121	121	100	100	100

Map Display Mode

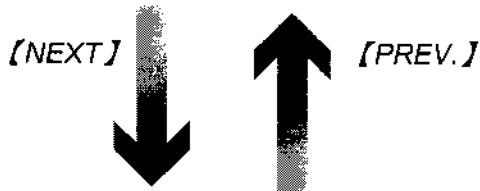

```

Ne 1: 400 rpm
Pr 1: 1000...
[1.214] → [*.***]
    
```

Data Changing Mode

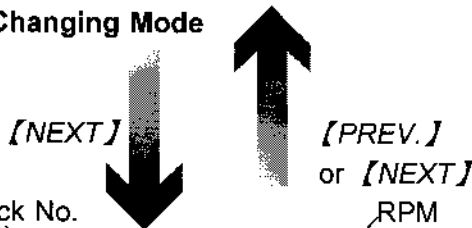

RPM block No. RPM

```

Ne 1: 400 rpm
Press. blockNo → Pr 1: 1000...
Press. Value → [1.214] → [1.250]
    
```

Original Fuel Corr. After Changing Fuel Corr.

advice!

The Fuel Correction value is...If the air fuel ratio is 12.0, then the corr. value would be 14.57/12.00=1.214. This is for reference only. Even changing the air cleaner could change actual figures.

Fuel Correction Value

① 《Map Display Mode》

【▲】 up key / 【▼】 down key

【◀】 left key / 【▶】 right key

Use these keys to select

The selected block will illuminate

② 《→ Data Changing Mode》

【NEXT】 key

This will activate the Data Changing Mode

The 【PREV.】 key will return to the Setting Mode Menu.

advice!

In this mode,

【▲】 up key / 【▼】 down key

【◀】 left key / 【▶】 right key

these keys will allow movement throughout the map.

③ 《Data Selection》

【NEXT】 key

This key will allow modification to selected data

④ 《Changing Data》

【▲】 up key / 【▼】 down key

Use these keys to change data

⑤ 《Data Entry》

【NEXT】 key

Use this key to enter data

The 【PREV.】 key will return to the Data Changing Mode without making any modifications to the current data.

■ setting 《Changing Press. Sensor Characteristics and Basic Fuel Injection》

②-d CHANGING PRESS. SENSOR CHARACTERISTICS

【setting】 → 【PIM Volt】

This function is used when the Boost levels of a particular car exceed the measuring capacity of the existing pressure sensor. In this case, a new pressure sensor must be used. The Exhaust Temperature Warning Indicator will illuminate when the Boost Level exceed the capacity of the current pressure sensor. Pressure sensor data can be modified at APEX Power Excel Dealers.

advice!!

- Factory Press. Sensor Capacity · Absolute Press. 0 [kg/cm²] ~ 2. 2 [kg/cm²]
- For BOOST CONTROL KIT
Press. Sensor Capacity · Absolute Press. 0 [kg/cm²] ~ 3. 0 [kg/cm²]
Normal boost is Absolute press. minus approx. 1. 0 3 3 [kg/cm²] (7 6 0 [mmHg])

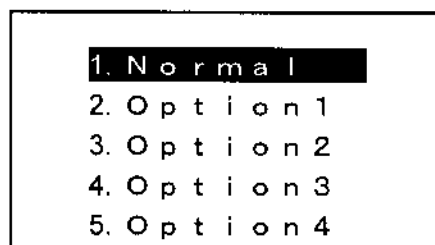

IGL Map	Boost
IGT Map	Acceler.
Inj Map	IGL/T, Fi
PIM Volt	Wtr Temp
Injector	Rev/Idle

① 《Pressure Sensor Selection》

【▲】 up key / 【▼】 down key

Use this key to select pressure sensor

The selected sensor will illuminate

Usually, 1. Normal will be used.

② 《Pressure Sensor Entry》

【PREV.】 key

Use this key to finalize pressure sensor selection

It will return to the Setting Mode Menu

The 【NEXT】 key will allow activation of the detailed adjustment mode

■ setting 《Changing Press. Sensor Characteristics and Basic Fuel Injection》

● Basic Fuel Injection Correction 【setting】 → 【PIM Volt】

This mode allows modifications to the Basic Fuel Injection map by correcting the voltage and RPM.

1. Normal

2. Option 1

3. Option 2

4. Option 3

5. Option 4

8000 r pm 100.0%

7000 r pm 100.0%

6000 r pm 100.0%

5000 r pm 100.0%

4000 r pm 100.0%

3000 r pm 100.0%

2000 r pm 100.0%

1000 r pm 100.0%

PIM 1.0V 100.0%

PIM 1.5V 100.0%

PIM 2.0V 100.0%

PIM 2.5V 100.0%

PIM 3.0V 100.0%

PIM 3.5V 100.0%

PIM 4.0V 100.0%

PIM 4.5V 100.0%

③ 《Pressure Sensor Selection》

【▲】 up key / 【▼】 down key

Use this key to select Pressure Sensor

The selected menu will illuminate

③-1 《Engine RPM Specific Correction》

【▲】 up key / 【▼】 down key

Use these keys to select desired Engine RPM

The selected RPM will illuminate

After Selection

【▶】 right key

It is now possible to change the correction value

【▲】 up key / 【▼】 down key

Use these keys to change the value

Increasing over 100.0 % will add to the Basic Fuel Injection and decreasing will lessen the Basic Fuel Injection amount.

③-2 《Pressure Sensor Voltage Selection》

【▲】 up key / 【▼】 down key

Use these keys to select Press. Sensor Voltage

The selected voltage will illuminate

After selecting

【▶】 right key

It is now possible to change the correction value

【▲】 up key / 【▼】 down key

Use these keys to change value

Increasing over 100.0 % will add to the Basic Fuel Injection and decreasing will lessen the Basic Fuel Injection amount.

■ setting 《Injector Pulse Timing Correction》

③-e Injector Pulse Timing Correction 【setting】 → 【injector】

Used when correcting for upgraded injectors and cylinder specific fuel correction.

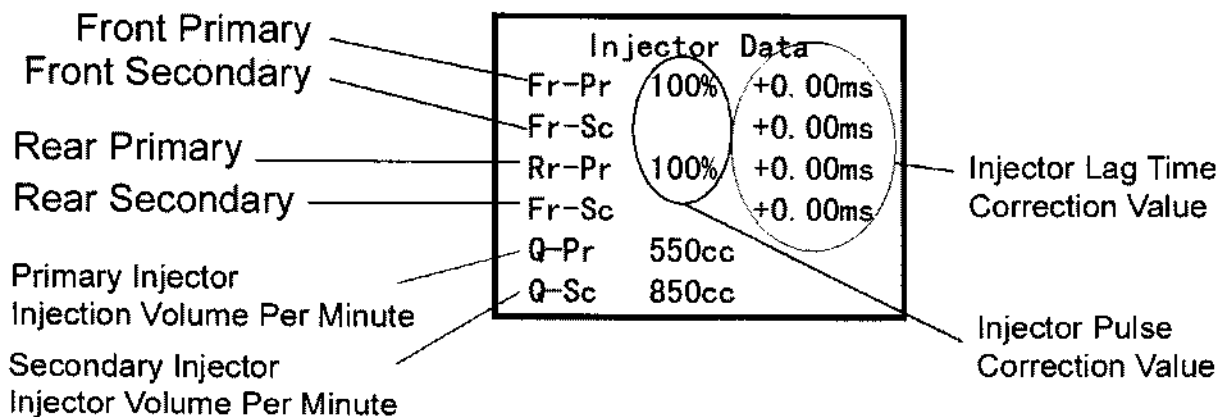

Injector Data		
Fr-Pr	100.0%	+0.00ms
Fr-Sc		+0.00ms
Rr-Pr	100.0%	+0.00ms
Rr-Sc		+0.00ms
Q-Pr	550cc	
Q-Sc	850cc	

① 《Selecting Modification Parameter》

【▲】 up key / 【▼】 down key

Use this key to select parameter

The selected parameter will illuminate

Injector Data		
Fr-Pr	100.0%	+0.00ms
Fr-Sc		+0.00ms
Rr-Pr	100.0%	+0.00ms
Rr-Sc		+0.00ms
Q-Pr	550cc	
Q-Sc	850cc	

② 《Injector Pulse Correction and Injector Lag Time Correction》

※ After selecting parameter

【▶】 right key / 【◀】 left key

Use these keys to selected desired location

The selected location will illuminate.

In addition,

【▲】 up key / 【▼】 down key

Use these keys to change the values

IGL Map	Boost
IGT Map	Acceler.
Inj Map	IGL/T, Fi
PIM Volt	Wtr Temp
Injector	Rev/Idle

③ 《End Correction》

【PREV.】 key

Use this key to save the data and return to the Setting Mode

■ setting 《Injector Pulse Timing Correction Procedures》

advice!

● Reference Data

FD3S (13B-REW) Factory injectors

■ Primary

- Injector volume approx. 550 [cc/min] (according to manufacturer)
- Injector Lag Time approx. 0.73 [msec] (battery voltage 14V, APEX tested)

■ Secondary

- Injector Volume approx. 850 [cc/min] (according to manufacturer)
- Injector Lag Time approx. 0.77 [msec] (battery voltage 14V, APEX tested)

※ Actual injector volume will vary with manufacturer claims according to fuel pump and fuel pressure.

● About the Input Data

• If Changing the Primary Injectors

Please change the data for injector pulse value and the injector volume for 1 minute

• If Changing the Secondary Injectors

Please change the injector volume for 1 minute.

• Injector Lag Time Correction

Please change the data for the upgraded injector

▪ CAUTION

Be sure to set the 1 minute injector volume within the formula $Q-Sc \geq Q-Pr$.

~ Example ~

If changing: primary injector volume to 660cc/min and the injector's lag time is 0.75ms,
secondary injector volume to 950cc/min and the injector's lag time is 0.80ms,

- Injector Pulse Correction Value would be (Setting for Primary Injector only)

$$550 \div 660 = 0.833 \quad \text{approx. } 83.5\%$$

- Injector Lag Time would be,

$$\text{(Primary)} \quad 0.75 - 0.73 = +0.02[\text{msec}] \quad \text{(Secondary)} \quad 0.80 - 0.77 = +0.03[\text{msec}]$$

- 1 minute injector volume would be

$$\text{(Primary)} \quad 660[\text{cc/min}] \quad \text{(Secondary)} \quad 950[\text{cc/min}]$$

With the example stated above, the following data would appear as on the left.

Injector Data		
Fr-Pr	83.5%	+ 0.02ms
Fr-Sc		+ 0.03ms
Rr-Pr	83.5%	+ 0.02ms
Rr-Sc		+ 0.03ms
Q-Pr	660cc	
Q-Sc	950cc	

■ setting 《Boost Setting》

③-f Boost Setting 【setting】 → 【Boost】

Two boost settings can be put into Memory. Per setting, there is a Primary (Pr) and Secondary (Sc) setting. By utilizing a self learning function, ideal boost response and stability is achieved for that particular car.

Setting Number Set Boost Level Base Duty

Setting Number	Boost Pressure	Set Boost Level	Base Duty
1	Pr	0.80kg/cm ²	56 %
	Sc	0.70kg/cm ²	64 %
2.	Pr	0.90kg/cm ²	62 %
	Sc	0.80kg/cm ²	70 %

① 《Setting Number Selection》

【▲】 up key / 【▼】 down key

Use these keys to select setting selection
The selected item will illuminate.

Setting Number	Boost Pressure	Set Boost Level	Base Duty
1	Pr	0.80kg/cm ²	56 %
	Sc	0.70kg/cm ²	64 %
2.	Pr	0.90kg/cm ²	62 %
	Sc	0.80kg/cm ²	70 %

② 《Boost Pressure/ Base Duty Setting》

【◀】 left key / 【▶】 right key

Use these keys to move to desired location
The desired location will illuminate

Also,

【▲】 up key / 【▼】 down key

Use these keys to change values

IGL Map	Boost
IGT Map	Acceler.
Inj Map	IGL/T, Fi
PIM Volt	Wtr Temp
Injector	Rev/Idle

③ 《End Setting》

【PREV.】 key

Use this key to save data and return to the setting menu.

advice!

The self learning value is for reference purposes only. Even if the self learning value does not change, if boost pressure is stable, there is no problem with boost control.

■ setting 《Boost Setting》

advice!

● About Setting Boost . . .

Two patterns of boost can be input: One for Primary and Secondary, ranging from 0.5kg/cm^2 ~ 2.0kg/cm^2 for each, in 0.05kg/cm^2 increments.

When using the factory pressure sensor, boost levels over 1.2kg/cm^2 cannot be accurately measured. For this reason, the POWER FC will illuminate the Exhaust Temp. Warning Indicator for boost levels over 1.1kg/cm^2 to notify the user that the boost levels have exceeded the measuring capacity.

(The Boost setting can be set to a level below the actuator capabilities. However, actual boost levels CANNOT go below the actuator limits.)

● When using the BOOST CONTROL KIT . . .

Use the BOOST CONTROL KIT when upgrading the turbos or when the factory sequential turbo system is not being used. The BOOST CONTROL KIT will only utilize the Primary setting for boost control.

● About Boost Control . . .

The POWER - FC controls boost by using the duty cycle of the solenoid valve.

This duty cycle is the percentage of open and closed cycles for the solenoid valve in a given amount of time.

● About Base Duty . . .

The solenoid valve duty must be changed in order to achieve desired boost levels. The duty cycle required to hit a certain boost level is usually determined by the wastegate spring. When changing the desired Boost Level, please change the Base Duty. Even if the Base Duty is not exact, the unit will compensate during driving and correct the difference. The larger the Base Duty, the higher the boost level, the smaller the Base Duty, the lower the boost level.

● About Fuel Cut associated with High Boost Levels . . .

If the Boost level rises above 0.25 [kg/cm^2] over the preset Boost Levels, a fuel cut will occur thereby notifying the user of a Boost Control problem.

▪ CAUTION

When using a Boost Controller other than the POWER-FC, be sure to set the POWER-FC boost to a level where fuel cut will not occur.

■ setting 《Acceleration Enrichment Correction》

③-g Acceleration Enrichment Correction

【setting】 → 【Acceler.】

This parameter improves the response under hard and sudden acceleration. Extra fuel is added to the base map to compensate for drastic accelerator movement through this parameter.

In this mode, the acceleration enrichment fuel is set according to engine RPM.

Accelerate Inj. Time		
5000rpm	7.5 ms	1.0 ms
4000rpm	7.5 ms	1.0 ms
3000rpm	7.5 ms	1.5 ms
2000rpm	8.0 ms	1.8 ms
1000rpm	6.0 ms	2.0 ms

RPM / Decay Time Value
Accelerator Enrichment Value

Accelerate Inj. Time		
5000rpm	7.5 ms	1.0 ms
4000rpm	7.5 ms	1.0 ms
3000rpm	7.5 ms	1.5 ms
2000rpm	8.0 ms	1.8 ms
1000rpm	6.0 ms	2.0 ms

IGL Map	Boost
IGT Map	Acceler.
Inj Map	IGL/T, Fi
PIM Volt	Wtr Temp
Injector	Rev/Idle

① 《RPM Selection》

【▲】 up key / 【▼】 down key

Use these keys to select RPM

The selected RPM will illuminate

② 《Enrichment Value, Decay Time Value》

※ After selecting RPM setting

【◀】 left key / 【▶】 right key

Use these keys to select item to be changed

The selected parameter will illuminate

In addition,

【▲】 up key / 【▼】 down key

Use these keys to change values

③ 《End Setting》

【PREV.】 key

Use this key to save data and return to the Setting Mode.

advice!

● About the Input Data . . .

The Acceleration Enrichment Value is the value for the maximum injection amount when there is drastic accelerator movement. If accelerator movement is minimal, this value will be used as a base reference point to compensate for less movement.

The acceleration enrichment fuel is added to the base fuel injection amount as soon as there is accelerator movement.

The fuel enrichment added is,

[Previous Accel. Enrichment Value - Decay Time Value]

■ setting 《Fuel / Ignition Timing Test Correction》

③-h Fuel / Ignition Timing Correction

【setting】 → 【Ign/Inj】

This mode allows modifications to the Fuel injection and Ignition Timing Maps for a temporary amount of time to test engine condition. Since this is a test mode, all data is stored in this mode will be erased from memory once the Ignition Key has been turned OFF.

Ignition Timing Correction Value Fuel Correction Value

IGL Adj: +0	IGT Adj: +0	Inj Adj: 1.000
Map: 15°	Map: 15°	Map: 1.000
Fin: 15°	Fin: 15°	Fin: 2.5ms

Map Ignition Timing

Fuel Correction Map × Fuel Correction Value

Ignition Timing After Correction Basic Fuel Injection After Correction

IGL Adj: +0	IGT Adj: +0	Inj Adj: 1.000
Map: 15°	Map: 15°	Map: 1.000
Fin: 15°	Fin: 15°	Fin: 2.5ms

① 《Fuel Correction/ Ignition Timing Correction Selection》

【◀】 left key / 【▶】 right key

Use these keys to select correction parameter

The selected parameter will illuminate

② 《Fuel Correction, Ignition Correction Setting》

【▲】 up key / 【▼】 down key

Use these keys to adjust value

③ 《End Setting》

【PREV.】 key

Use this key to save data and return to the Setting Mode

IGL Map	Boost
IGT Map	Acceler.
Inj Map	IGL/T, Fi
PIM Volt	Wtr Temp
Injector	Rev/Idle

■ setting 《Water Temp Correction》

③-i Water Temp Correction 【setting】 → 【Wtr Temp】

Extra fuel is needed when the engine is cold due to denser air conditions. This mode allows correction for fuel according to various water temperatures.

Fuel Correction Value (low load)

Water Temp Correction		
+80 °C	1.00	1.00
+50 °C	1.07	1.01
+30 °C	1.29	1.21
+10 °C	1.57	1.50
-10 °C	2.01	1.87
-30 °C	2.81	2.57

Setting Water Temp

Fuel Correction Value (high load)

① 《Selecting Water Temp Setting》

【▲】 up key / 【▼】 down key

Use these keys to select

The selected Water Temp will illuminate

Water Temp Correction		
+80 °C	1.00	1.00
+50 °C	1.07	1.01
+30 °C	1.29	1.21
+10 °C	1.57	1.50
-10 °C	2.01	1.87
-30 °C	2.81	2.57

② 《Fuel Correction Value Setting》

※ After Selecting Water Temp

【▶】 right key / 【◀】 left key

Use these keys to select desired location

The selected location will illuminate

In addition,

【▲】 up key / 【▼】 down key

Use these keys to change values

advice!

Fuel correction values can be set for heavy load (right) and light load (left.)

IGL Map	Boost
IGT Map	Acceler.
Inj Map	IGL/T, Fi
PIM Volt	Wtr Temp
Injector	Rev/Idle

③ 《End Setting》

【PREV.】 key

Use this key to save data and return to Setting Mode.

Or,

《Changing Cranking Fuel Injection》

【NEXT】 key

Use this key to move to the *Changing Cranking Fuel Injection Mode.*

Cranking Inj.Time	
+80 °C	4.0msec
+50 °C	7.0msec
+30 °C	12.0msec
+10 °C	25.0msec
-10 °C	50.0msec
-30 °C	98.0msec

■ setting 《Changing Cranking Fuel Injection》

③-j Changing Cranking Fuel Injection

【setting】 → 【Wtr Temp】

This mode corrects the fuel amount during cranking the engine, and when the engine water temp is cold. Adjustments are made according to various water temps.

Cranking Inj. Time	
+80 °C	4.0msec
+50 °C	7.0msec
+30 °C	12.0msec
+10 °C	25.0msec
-10 °C	50.0msec
-30 °C	98.0msec

Water Temp Setting Fuel Injection Time

① 《Selecting Water Temp Setting》

【▲】 up key / 【▼】 down key

Use these keys to select water temp

The selected water temp will illuminate.

Cranking Inj. Time	
+80 °C	4.0msec
+50 °C	7.0msec
+30 °C	12.0msec
+10 °C	25.0msec
-10 °C	50.0msec
-30 °C	98.0msec

② 《Setting Fuel Injection》

※ After Setting Water Temp

【▶】 right key / 【◀】 left key

Use these keys to select desired location

The desired location will illuminate

In addition

【▲】 up key / 【▼】 down key

Use these keys to change the values

IGL Map	Boost
IGT Map	Acceler.
Inj Map	IGL/T, Fi
PIM Volt	Wtr Temp
Injector	Rev/Idle

③ 《End Setting》

【PREV. key】

Use this key to save data and return to the Setting Mode

Or,

《Water Temp Correction》

【NEXT】 key

Move to the Water Temp Correction Screen.

Water Temp Correction		
+80 °C	1.00	1.00
+50 °C	1.04	1.09
+30 °C	1.14	1.29
+10 °C	1.25	1.50
-10 °C	1.39	1.68
-30 °C	1.59	2.00

■ setting 《RPM Setting》

③-k RPM Setting 【setting】 → 【Rev/Idle】

This mode controls RPM levels for Rev Limiter and Idle.

Rev. Limit		8100rpm
F/C A・E オフ		1000rpm
F/C E/C オン		1100rpm
F/C A/C オン		1200rpm
IDLE A・E オフ		720rpm
IDLE E/L オン		800rpm
IDLE A/C オン		900rpm

Setting Parameter

Setting RPM

① 《Selecting Parameter》

【▲】 up key / 【▼】 down key

Use these keys to select parameter
The selected parameter will illuminate

Rev. Limit	8100 rpm
F/C A・E オフ	1000rpm
F/C E/C オン	1100rpm
F/C A/C オン	1200rpm
IDLE A・E オフ	720rpm
IDLE E/L オン	800rpm
IDLE A/C オン	900rpm

② 《Parameter Setting》

※ After Parameter Selection

【▶】 right key

Use this key to select desired location
The selected location will illuminate

In addition,

【▲】 up key / 【▼】 down key

Use these keys to change values.

IGL Map	Boost
IGT Map	Acceler.
Inj Map	IGL/T, Fi
PIM Volt	Wtr Temp
Injector	Rev/Idle

③ 《End Setting》

【PREV.】 key

Use this key to save data and return to the Setting Mode

advice!

● About Input Data . . .

[Rev. Limit] .. Sets Rev Limiter RPM

[F/C A・E オフ] .. Deceleration fuel cut recovery RPM setting, when air conditioning. is OFF, and there is no electrical load on the car.

[F/C E/L オン] .. Deceleration fuel cut recovery RPM setting when there is electrical load

[F/C A/C オン] .. Deceleration fuel cut recovery RPM setting when the air cond. is ON

[IDLE A・E オフ] .. Sets idling RPM level for when A/C and electrical load are OFF.

[IDLE E/L オン] .. Sets idling RPM level when there is electrical load (ON)

[IDLE A/C オン] .. Sets idling RPM level when the air conditioning is ON

● About the RPM Settings

The difference between the deceleration fuel cut recovery RPM setting and Idle RPM cannot be set under 100rpm. When setting the Idle RPM, use an applicable deceleration fuel cut recovery RPM setting.

■ etc. 《Other》

④ Other 【etc.】

Selecting 【etc.】 on the Main Menu will activate the OTHER Setting Mode.

● Etc. Menu

④-a[Prog. Version]	<i>Program Version Display</i>	P35
④-b[Sensor/SW check]	<i>Input/Output Signal Check Display</i>	P35
④-c[Function Select]	<i>Original Function Setting</i>	P36
④-d[LCD/LED adjust]	<i>Display Screen Adjustment</i>	P38
④-e[All Data Init.]	<i>Initialize All Data</i>	P38

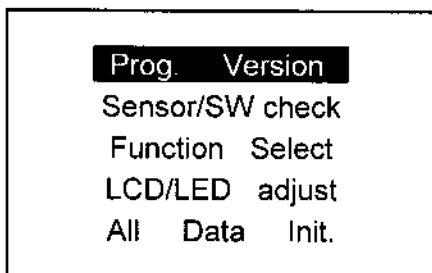

① 《Etc. Mode Selection》

【▲】 up key / 【▼】 down key

Use these keys to select desired parameter
The selected parameter will illuminate

② 《Etc. parameter Entry》

【NEXT】 key

Use this key to enter
The selected parameter will appear



③ 《Ending Etc. Mode》

【PREV.】 key

Use this key to exit mode.
After the setting parameter selection, the screen will go to the setting parameter selection menu.
After the setting parameter selection menu The screen will go to the main menu.

※ 【PREV.】 key returns to the previous menu.

■ etc. 《Program Version Display, Input Output Check Display》

④-a Program Version Display 【etc.】 → 【Prog.Version】

This will display the POWER-FC, FC-COMMANDER program version and applicable vehicle engine type.

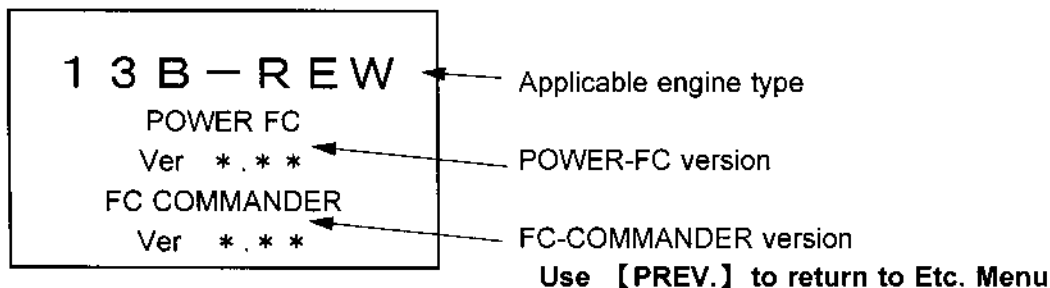

④-b Input Output Check Display 【etc.】 → 【Sensor/SW Check】

This mode is used to check sensor voltage, and proper switch operation

Use this mode to check for malfunctions when the Engine Check Lamp is ON.

The malfunctioning sensor will illuminate.

※ Displayed signals will vary according to car

Abnormal Sensor Voltage Output Switch Operation

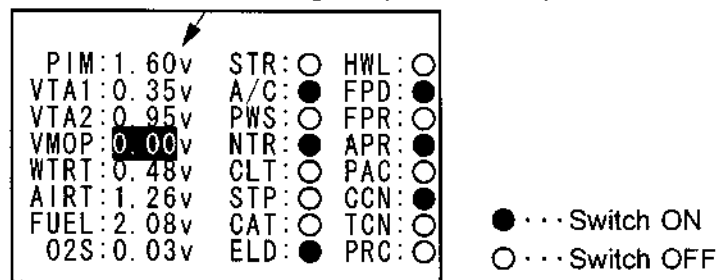

~ Display Contents ~

● Sensor Types

[PIM] ...Pressure Sensor	[WTRT] ...Water Temp Sensor
[VTA1] ...Throttle Sensor 1 (full range)	[AIRT] ...Intake Air Temp Sensor
[VTA2] ...Throttle Sensor 2 (narrow range)	[FUEL] ...Fuel Temp Sensor
[VMOP] ...Metering Oil Pump Position Sensor	[O2S] ...O ₂ Sensor

● Switch Types

[STR] ...Starter Switch	[HWL] ...Exhaust Temp Warning Indicator
[A/C] ...Air Conditioning Switch	[FPD] ...Fuel Pump Operation
[PWS] ...Power Steering Oil Press. Sw.	[FPR] ...Fuel Pump Control
[NTR] ...Neutral Switch	[APR] ...Air Pump Relay
[CLT] ...Clutch Switch	[PAC] ...Port Air Control
[STP] ...Stop Switch	[CCN] ...Charge Control
[CAT] ...Catalyzer Thermo Sensor Sw.	[TCN] ...Turbo Control
[ELD] ...Electrical Load Switch	[PRC] ...Pressure Regulator Control

■ etc. 《Original Function Setting》

③-c Original Function Setting

【etc.】 → 【Function Select】

This mode enables/disables: sequential turbo control system, various warning indicators, O₂ feedback control functions.

アリ = enable and ナシ = disable

Function Select	
1. Seq. Turbo Cont	アリ
2. Injector Warn.	アリ
3. Knock Warning	アリ
4. O ₂ F/B Control	アリ
5. Idel-IG Cntrl	アリ

① 《Selecting Parameter》

【▲】 up key / 【▼】 down key

Use this key to select parameter

The selected parameter will illuminate

Function Select	
1. Seq. Turbo Cont	アリ
2. Injector Warn.	アリ
3. Knock Warning	アリ
4. O ₂ F/B Control	アリ
5. Idel-IG Cntrl	ナシ

② 《Parameter Entry》

※ After Selecting Parameter

【▶】 right key

Use this key to select.

The selected parameter will illuminate.

In addition,

【▲】 up key / 【▼】 down key

Use these keys to select between アリ (enable) / ナシ (disable)

Prog. Version
Sensor/SW check
Function Select
LCD/LED adjust
All Data Init.

③ 《End Setting》

【PREV.】 key

Use this key to save data and return to the Etc. Mode

■ etc. 《Original Function Setting》

advice!

● About the Setting Parameters . . .

- [Seq.Turbo Cont] . . . Enables or Disables the sequential turbo control system.
Be sure to set to [ナシ] (off) when NOT using the sequential turbo control system

- [Inj/AirF Warn.] . . . Enable or Disable the Engine Check Lamp warning indicator when the injectors are at maximum (over 98%)、airflow voltage is at maximum (5.1V) Indicator flashes in 0.5 second increments.

- [Knock Warning] . . . Enable or Disable Engine Check lamp Warning indicator when the detonation level exceeds 60. Indicator will flash in 0.1 second increments 3 times.

- [O₂ F/B Control] . . . Enable or Disable O₂ feedback control.
Disable only when O₂ sensor is damaged [ナシ]

- [Idle-IG Cntrl] . . . Enable or Disable Ignition timing Control for stable idle.
Only disable when checking Ignition Timing [ナシ]
Ignition Timing will be constant during idle at this time.

■ CAUTION

- Detonation Levels (knocking) over 60 does NOT necessarily mean that the vehicle is detonating. Please use this only as a reference.
- Always keep the O₂ feedback control ON [アリ] for exhaust fume purification.

■ etc. 《Display Brightness》

④-d Display Brightness 【etc.】 → 【LCD/LED adjust】

This mode adjusts the LCD contrast and LED Backlighting brightness.

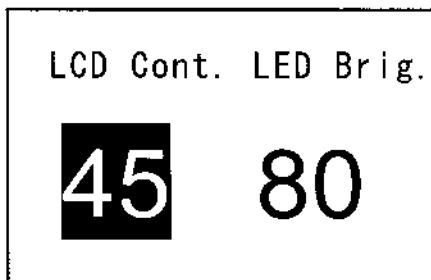

① 《Selecting Parameter》

【◀】 left key / 【▶】 right key

Use these keys to select desired parameter
The selected parameter will illuminate

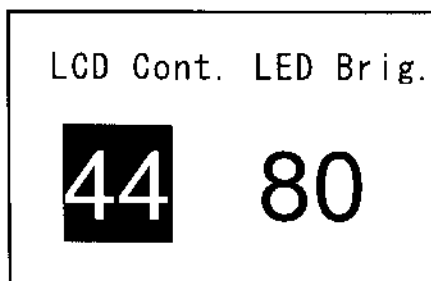

② 《Changing Settings》

【▲】 up key / 【▼】 down key

Use these keys to change values.

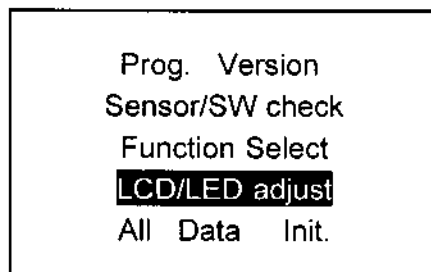

③ 《End Setting》

【PREV.】 key

Use this key to save data and return to the Etc. Mode

④-e Initialize All Data 【etc.】 → 【All Data Init.】

Restores all data to factory default settings.

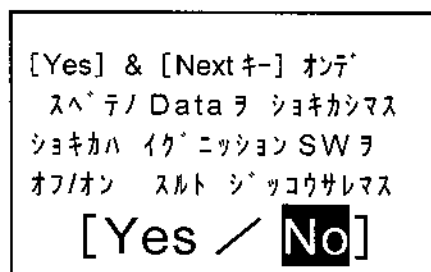

① 《Selecting Initialization》

【◀】 left key

Choose [Yes]

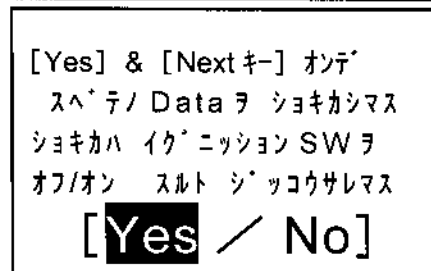

② 《Proceed with Initialization》

【NEXT】 key

Use this key to prepare for initialization

And then,

(IGNITION SWITCH) OFF → ON

will initialize all data

In Case of Malfunction

▪ WARNING

- **Discontinue use of this product immediately if there is smoke or a burning odor.**

Failure to do so may result in engine or vehicle fire. Please take the unit back to the place of purchase for further assistance.

▪ CAUTION

- **Never disassemble, modify, or tamper with this unit.**

Failure to do so may lead to electrical fire, vehicle fire, and engine damage.

- Apex reserves the right to change, modify, or discontinue this product without prior notification
- The instruction manual contents may change without prior notification.
- This product has been initially designed for Japanese market use.

This product is designed for Japanese domestic use only.

It must not be used in any country unless authorized through an APEX sales office.

APEX is not responsible for damage or harm caused by improper use of this product.

About the Warranty

This product does not carry any warranty outside of the Japanese market unless otherwise specified.

Manual Information

No.	Print Date	Product Number	Version	Notes
1	1998 july	K7507-0120-00	ver1	
2	1998 nov	K7507-0120-01	ver2	414-Z002 addition
3	1999 sept 6	K7507-0120-02	ver3	upgrade diagram



Contact

APEX CO.LTD

10440-1 Tana, Sagamihara-city, Kanagawa,229-1124 , Japan

Apex Integration Inc. (U.S.A.) 17091 Daimler St. Irvine, CA 92614)