

Before beginning any service procedure, refer to the 1993 RX-7 Body Electrical Troubleshooting Manual; see Section S for air bag system precautions and J1 for audio anti-theft system precautions.

## LUBRICATION SYSTEM

<b>INDEX</b> .....	D - 2
<b>OUTLINE</b> .....	D - 3
SPECIFICATIONS .....	D - 3
<b>TROUBLESHOOTING GUIDE</b> .....	D - 4
<b>OIL PRESSURE</b> .....	D - 5
PREPARATION .....	D - 5
INSPECTION .....	D - 5
<b>ENGINE OIL</b> .....	D - 6
INSPECTION .....	D - 6
REPLACEMENT .....	D - 6
<b>OIL FILTER</b> .....	D - 7
PREPARATION .....	D - 7
REPLACEMENT .....	D - 7
<b>OIL COOLER</b> .....	D - 8
REMOVAL / INSTALLATION .....	D - 8
<b>OIL PAN</b> .....	D - 9
PREPARATION .....	D - 9
REMOVAL / INSTALLATION .....	D - 10
<b>OIL PRESSURE CONTROL VALVE</b> .....	D - 13
REMOVAL / INSTALLATION .....	D - 13
<b>METERING OIL PUMP</b> .....	D - 14
PREPARATION .....	D - 14
INSPECTION .....	D - 15
<b>OIL PUMP</b> .....	D - 17
DISASSEMBLY / ASSEMBLY .....	D - 17
INSPECTION .....	D - 18

INDEX

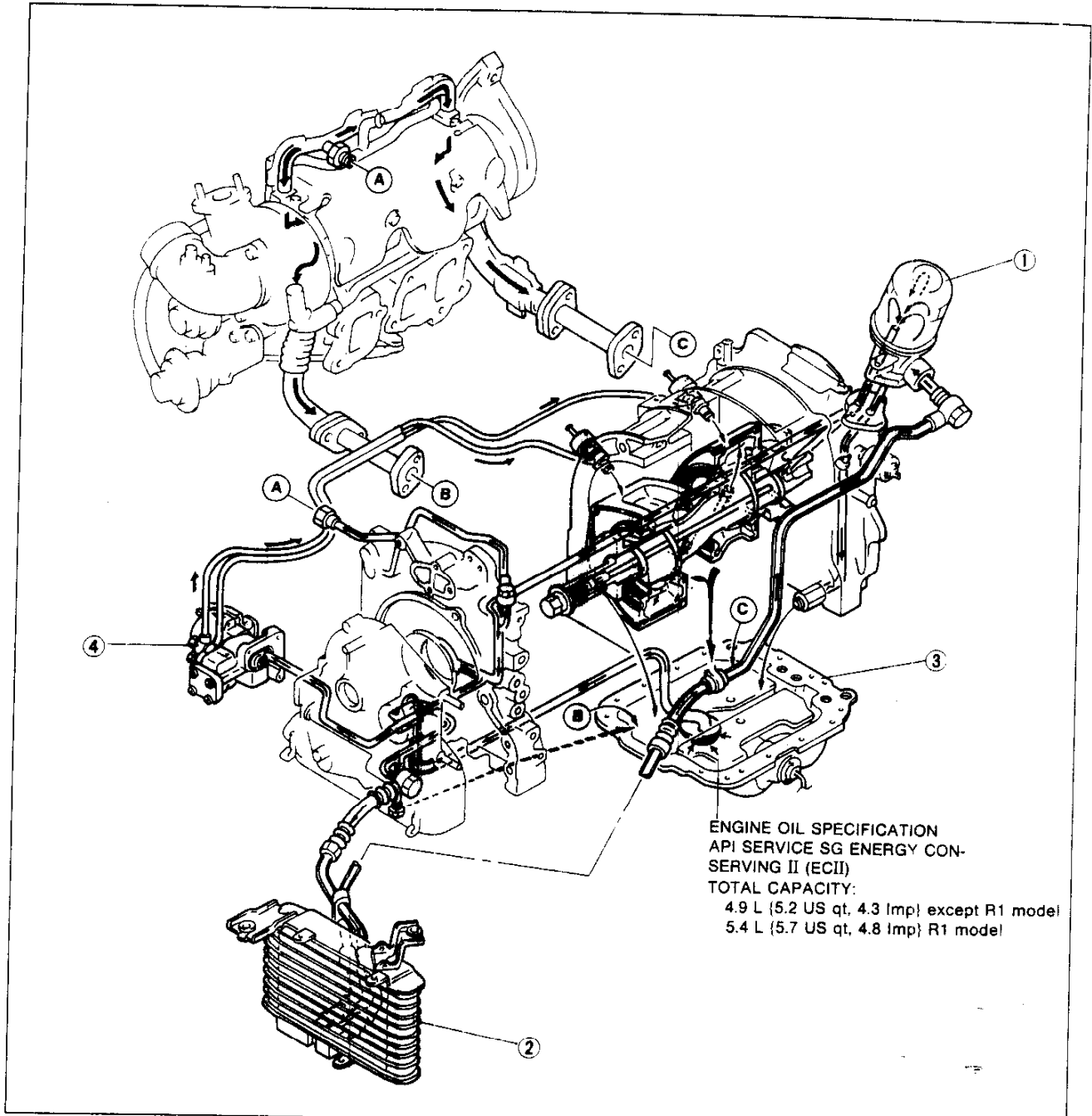

37U0DX-001

- 1. Oil filter  
 Replacement ..... page D-7
- 2. Oil cooler  
 Removal / Installation ..... page D-8

- 3. Oil pan  
 Removal / Installation ..... page D-10
- 4. Metering oil pump  
 Inspection ..... page D-14

OUTLINE

SPECIFICATIONS

Item	Engine model	13B Turbo
Lubrication system		Force-fed
Oil pump	Type	Trochoid
	Number of rotors	2
	Diameter × width of rotor mm {in}	50 × 17.5 {1.97 × 0.69}
Control valve relief pressure	kPa {kgf/cm <sup>2</sup> , psi}	1080 {11.0, 156}
Oil cooler	Type	Air-cooled, with bypass valve
	Relief temperature °C {°F}	60-65 {140-149} or below
	Relief pressure differential kPa {kgf/cm <sup>2</sup> , psi}	349 {3.56, 50} at 60°C {149°F}
Regulator valve relief pressure	kPa {kgf/cm <sup>2</sup> , psi}	780 {8.0, 110}
Oil filter	Type	Full-flow, paper element
	Relief pressure differential kPa {kgf/cm <sup>2</sup> , psi}	98 {1.0, 14}
Eccentric shaft bypass valve relief temperature	°C {°F}	60 {140} or below
Oil capacity	Total (dry engine) L {US qt, Imp qt}	4.9 {5.2, 4.3}...except R1 model 5.4 {5.7, 4.8}...R1 model
	Oil pan L {US qt, Imp qt}	3.9 {4.1, 3.4}
	Oil cooler L {US qt, Imp qt}	0.85 {0.90, 0.75}
	Oil filter Factory installed	0.19 {0.20, 0.17}
	L {US qt, Imp qt} Service part	0.17 {0.18, 0.15}
Engine oil (API service)		API Service SG Energy Conserving II (ECII)

37U0DX-303

Recommended SAE Viscosity

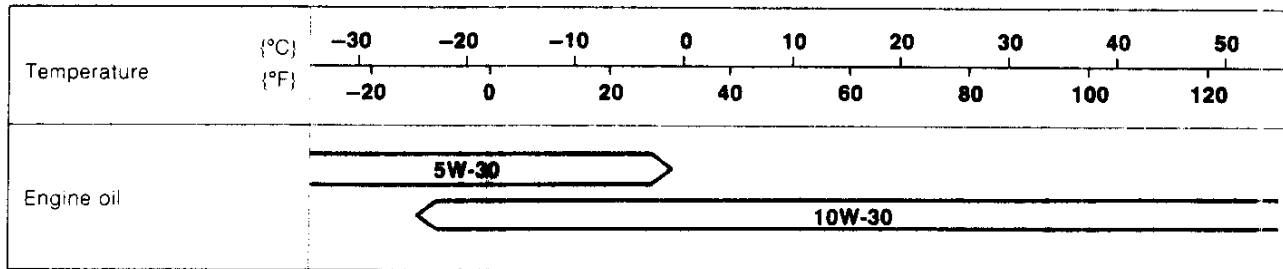

Anticipated ambient temperature range before the succeeding oil change. °C {°F}

97U0DX-104

# D

## TROUBLESHOOTING GUIDE

### TROUBLESHOOTING GUIDE

Problem	Possible Cause	Action	Page
<b>Engine hard starting</b>	Improper oil	Replace	D-6
	Insufficient oil	Add oil	D-6
<b>Excessive oil consumption</b>	Malfunction of metering oil pump mechanical component	Inspect	D-14
	Faulty oil nozzle	Inspect	D-17
	Oil leakage	Repair	-
<b>Oil leakage</b>	Loose drain plug or damaged washer	Tighten or replace	D-9
	Faulty seal at oil pan	Repair	D-9
	Damaged front cover	Replace	-
	Loose front cover bolt or oil pan bolt	Tighten	-
	Damaged sealing rubber, O-ring, or front cover gasket	Replace	-
	Malfunction of oil seal	Replace	-
	Loose oil filter	Tighten	D-7
	Loose or damaged oil level sensor or oil pressure gauge	Tighten or replace	-
	Damaged oil cooler or oil cooler hose	Replace	D-8
Damaged oil tube	Replace	-	
<b>Oil pressure drop*</b>	Oil leak	Repair	-
	Insufficient oil	Add oil	D-6
	Worn or damaged oil pump gear	Refer to Section C	-
	Clogged oil strainer	Clean	-
	Malfunction of oil pressure control valve	Replace	D-13
	Malfunction of oil pressure regulator valve	Replace	D-9
	Clogged oil filter	Replace	D-7
	Malfunction of eccentric shaft bypass valve	Refer to Section C	-
	Excessive oil clearance between eccentric shaft and main bearing	Refer to Section C	-
<b>Oil pressure gauge does not work</b>	Oil pressure drop	As described above	D-5
	Malfunction of oil pressure gauge unit	Refer to Section T	-
	Malfunction of electrical system	Refer to Section T	-
<b>Oil level warning indicator illuminates when engine is running</b>	Insufficient oil	Add oil	D-6
	Malfunction oil level sensor	Refer to Section T	-
	Malfunction of electrical system	Refer to Section T	-
<b>Poor acceleration</b>	Malfunction of metering oil pump electrical component	Inspect	D-14
<b>Rough idle</b>	Malfunction of metering oil pump electrical component	Inspect	D-14

37U00X-005

\* Oil pressure becomes low when the engine is cold because the eccentric shaft bypass valve operates.

## OIL PRESSURE

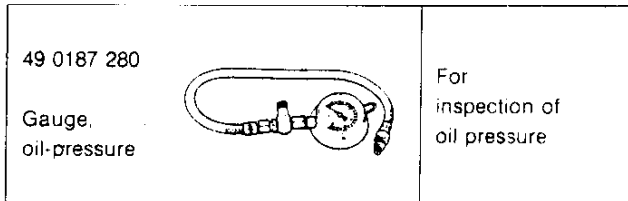
PREPARATION  
SST

37U0DX-006

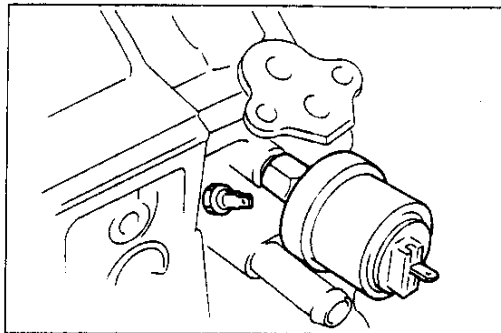

37U0DX-007

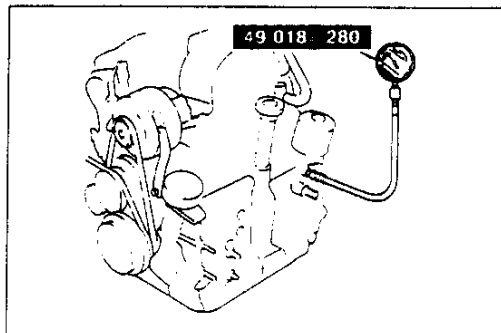

37U0DX-008

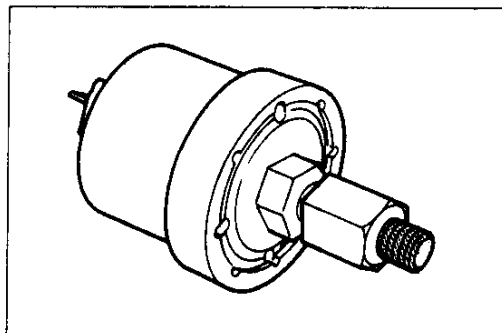

37U0DX-009

## INSPECTION

1. Disconnect the connector and remove the oil pressure switch.

2. Install the **SST**.

3. Start the engine and let it warm up to operating temperature.

4. Run the engine at 3,000 rpm and note the gauge reading.

**Oil pressure: 340 kPa (3.5 kgf-cm<sup>2</sup>, 50 psi) min**

5. If the pressure is not as specified, check for the cause and repair. (Refer to Troubleshooting Guide.)

6. Remove the **SST**.

7. Apply sealant to the threads and install the oil pressure switch.

**Tightening torque:**

**11–15 N·m {1.1–1.6 kgf·m, 8–11 ft·lbf}**

**Caution**

● **Do not allow sealant in the orifice of the oil pressure switch.**

8. Connect the switch connector.

# D

## ENGINE OIL

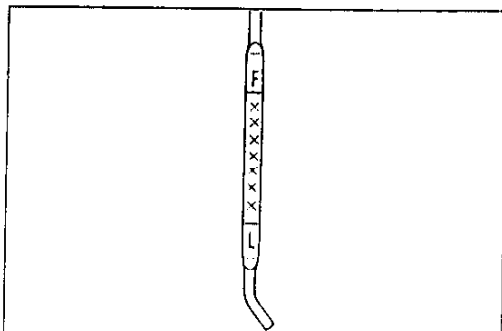

37U0DX-010

### ENGINE OIL

#### INSPECTION

1. Be sure the vehicle is on level ground.
2. Warm up the engine to normal operating temperature and stop it.
3. Wait for five minutes.
4. Remove the oil dipstick and check the oil level and condition.
5. Add or replace oil as necessary.

#### Note

- The distance between the L and F marks on the dipstick represents 1.7 L {1.8 US qt, 1.5 Imp qt}.

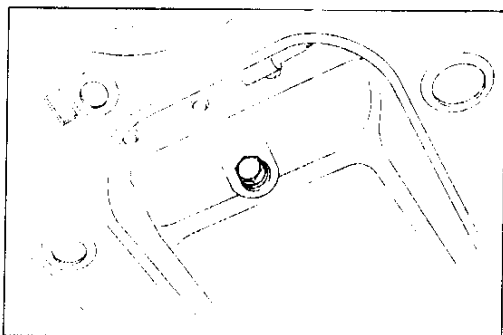

37U0DX-011

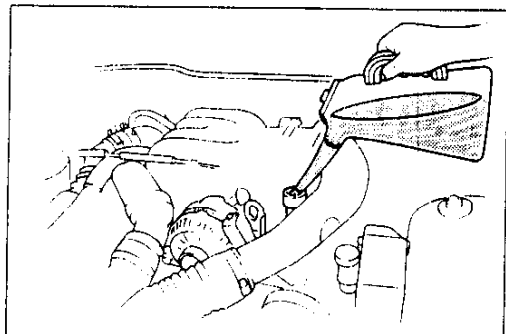

37U0DX-012

#### REPLACEMENT

##### Warning

- Be careful when draining; the oil is hot.

1. Warm up the engine to the normal operating temperature and stop it.
2. Remove the oil filler cap and the oil drain plug.
3. Drain the oil into a suitable container.
4. Install a new gasket and the drain plug.

##### Tightening torque:

**30–41 N·m {3.0–4.2 kgf·m, 22–30 ft·lbf}**

5. Refill the engine with the specified type and amount of engine oil.

##### Oil capacity:

L {US qt, Imp qt}

Total (dry engine)	4.9 {5.2, 4.3}...excepta R1 model 5.4 {5.7, 4.8}...R1 model
Engine oil replacement	3.5 {3.7, 3.1}
Engine oil replacement (with oil filter)	3.7 {3.9, 3.3}

6. Refit the oil filler cap.
7. Run the engine a few minutes and stop it.
8. Recheck the oil level and add oil if necessary.

## OIL FILTER



**PREPARATION**  
**SST**

<p>49 G014 001</p> <p>Wrench, oil filter</p>		<p>For removal/ installation of oil filter</p>
--	---	--

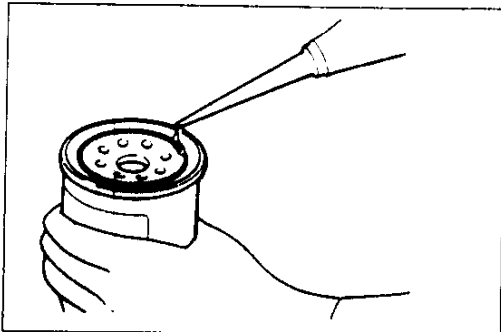
37U0DX-013

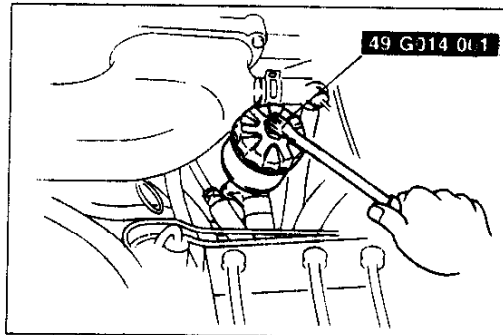

37U0DX-014



37U0DX-015

**REPLACEMENT**

1. Remove the oil filter by using the **SST**.
2. Using a clean rag, wipe the mounting surface on the engine.
3. Apply a small amount of clean engine oil to the rubber seal of the new filter.
4. Install the oil filter until the rubber seal contacts the base, and then tighten the filter an additional 1–1.6 turns by using the **SST**.
5. Start the engine and inspect for leaks around the filter seal.
6. Stop the engine and check the oil level; add oil if necessary.

**Note**

- The factory-installed oil filter and the service part filter are different.

**Service oil filter capacity:**

0.19 L {0.20 US qt, 0.17 Imp qt}

# D

## OIL COOLER

### OIL COOLER

#### REMOVAL / INSTALLATION

1. Disconnect the negative battery cable.
2. Remove in the order shown in the figure.
3. Install in the reverse order of removal.

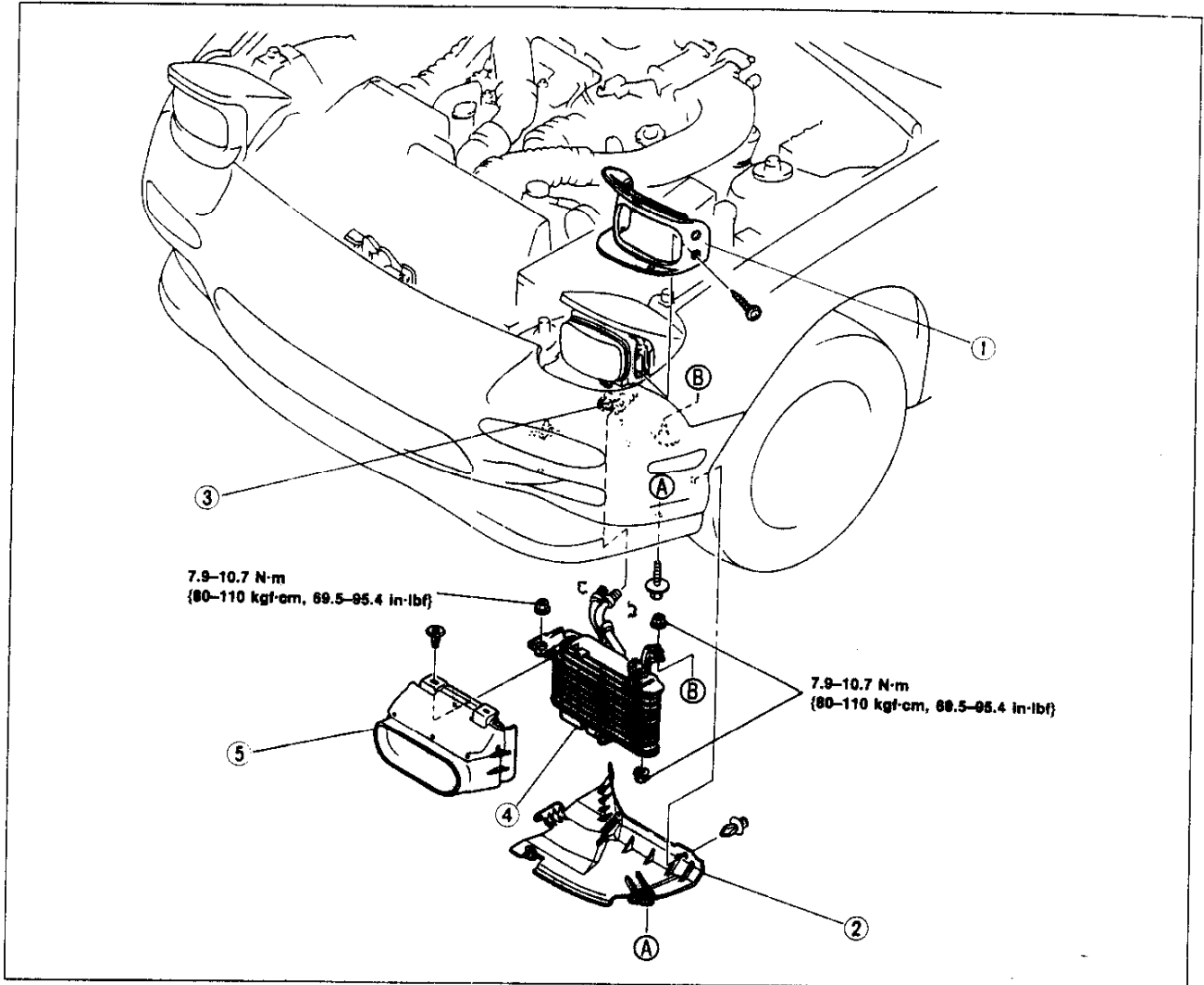

37U0DX-016

1. Lamp bezel
2. Brake pipe air duct  
Removal Note ..... page D-9
3. Oil cooler hoses  
Removal Note ..... page D-9

4. Oil cooler  
Removal Note ..... page D-9
5. Air duct (oil cooler)



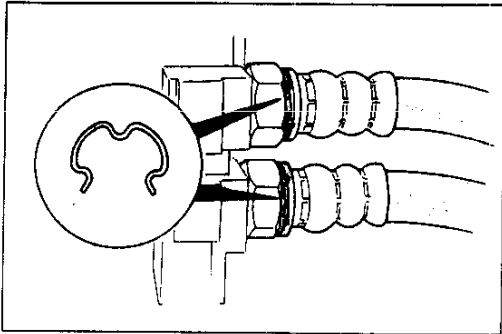

37U0DX-017

**Removal Note**  
**Oil cooler hose**

1. Remove the clip shown in the figure
2. Disconnect the oil hose.

**Caution**

- Use a drain pan to catch the oil when the oil hoses are disconnected.

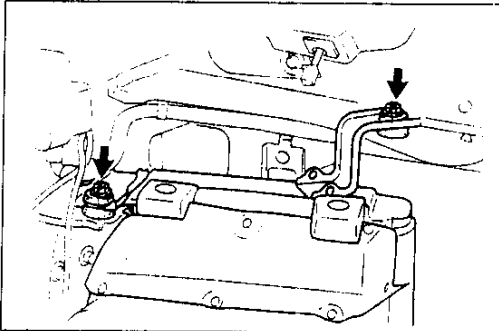

37U0DX-018

**Oil cooler**

1. Remove the lamp bezel.
2. Remove the mounting bracket nuts.
3. Remove the oil cooler.



**Step After Installation**

37U0D 019

Fill the engine with the specified amount and type of engine oil. (Refer to Inspection, page D-6)

**OIL PAN**

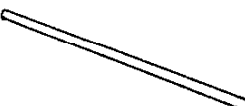
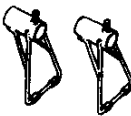
**PREPARATION**  
**SST**

<p>49 G017 5A0</p>  <p>Support, engine</p>	<p>For support of engine</p>	<p>49 G017 501</p>  <p>Bar (Part of 49 G017 5A0)</p>	<p>For support of engine</p>
<p>49 G017 502</p>  <p>Support (Part of 49 G017 5A0)</p>	<p>For support of engine</p>	<p>49 G017 503</p>  <p>Hook (Part of 49 G017 5A0)</p>	<p>For support of engine</p>

33U0EX-020

# D

## OIL PAN

### REMOVAL / INSTALLATION

1. Disconnect the negative battery cable.
2. Remove the undercover.
3. Drain the engine oil.
4. Remove in the order shown in the figure, referring to **Removal Note**.
5. Install in the reverse order of removal, referring to **Installation Note**.

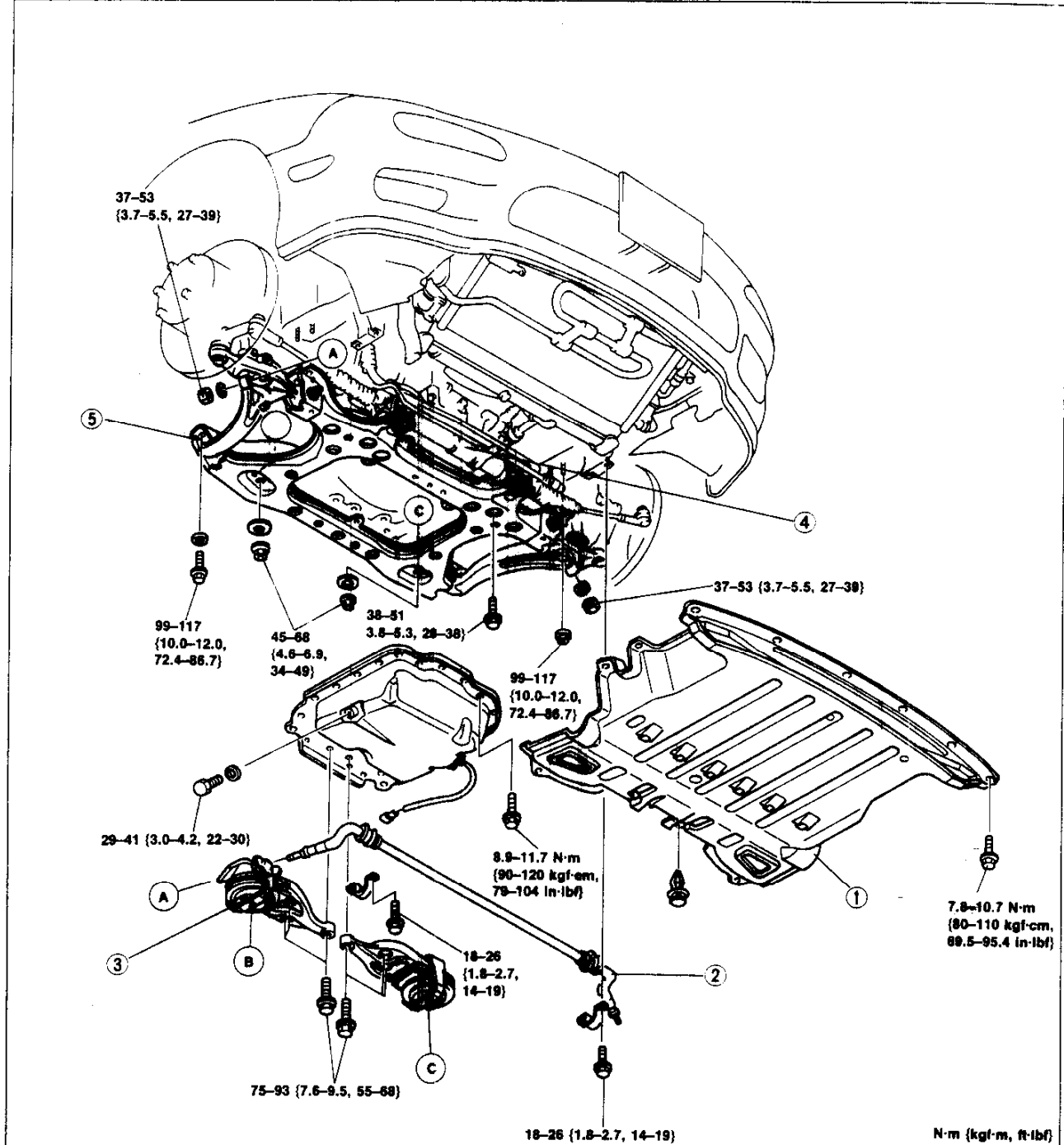

37U0DX-02

- |                              |                                   |
|------------------------------|-----------------------------------|
| 1. Undercover                | 5. Crossmember                    |
| 2. Stabilizer                | Removal Note ..... page D-11      |
| 3. Engine mount bracket      | 6. Oil pan                        |
| Removal Note ..... page D-11 | Removal Note ..... page D-11      |
| 4. Steering gear box         | Installation Note ..... page D-12 |

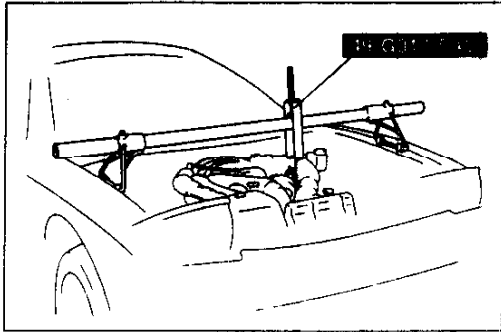

37U0DX-022

### Removal Note Engine mount bracket

1. Assemble the **SST** and connect the hook to the front engine hanger.

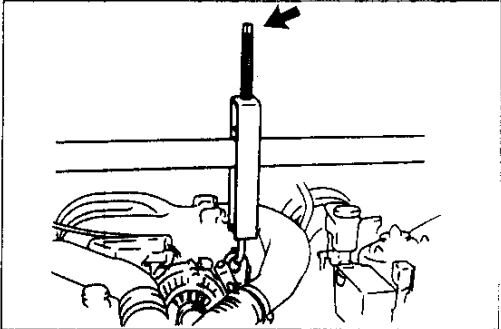

37U0DX-023

2. Remove the engine mounting nuts.  
3. Turn the bolt of the **SST** clockwise to lift the engine.

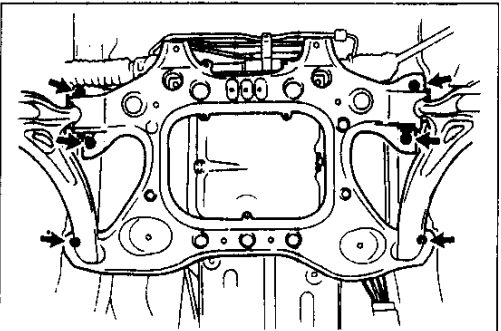

37U0DX-024

### Crossmember

1. Remove the power steering oil hose bracket from the crossmember.  
2. Remove the bolts and nuts (arrows) and the crossmember.

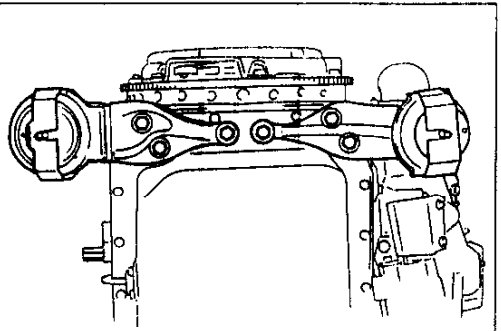

37U0DX-025

### Oil pan

1. Remove the engine mount brackets from the engine.  
2. Disconnect the oil level sensor connector and remove it from the harness bracket.  
3. Remove the oil pan mounting bolts.

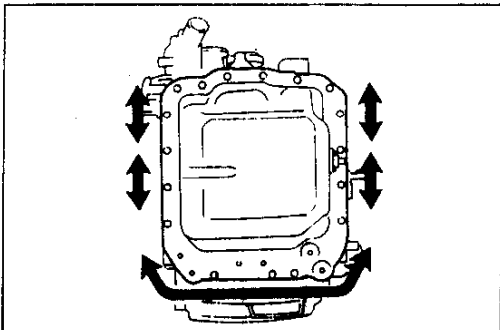

37U0DX-026

4. Insert a screwdriver or suitable tool only between the points shown in the figure to pry the oil pan loose.

# D

## OIL PAN

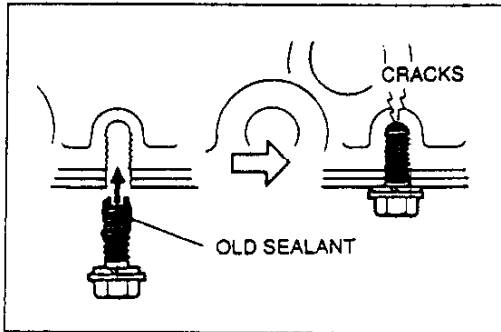

37U0DX-027

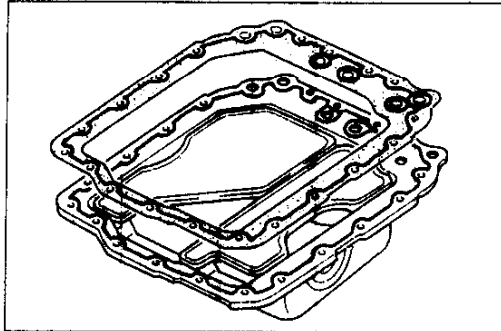

37U0DX-028

### Installation Note

#### Oil pan

1. Remove all foreign material from the oil pan contact surfaces.

#### Caution

- If the bolts are reused, remove the old sealant from the bolt threads. Tightening bolts with old sealant on them may cause cracking inside the bolt holes.
  - Secure the oil pan within 5 minutes after applying the sealant.
2. Apply silicone sealant to the contact surfaces of the oil pan and the engine side of the new gasket.
  3. Install the oil pan.

#### Tightening torque:

8.9–11.7 N·m {90–120 kgf·cm, 79–104 in·lbf}

### Step After Installation

Fill the engine with the specified amount and type of engine oil. (Refer to page Inspection, D-6.)

37U0DX-029

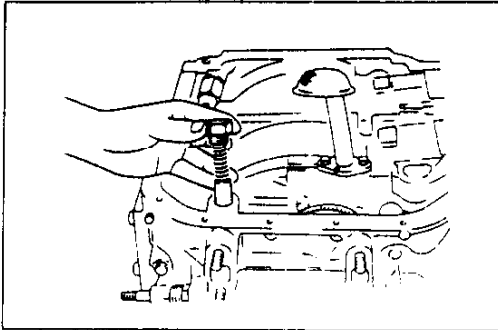

37U0DX-030

### OIL PRESSURE CONTROL VALVE REMOVAL / INSTALLATION

1. Remove the parts in the following order.
  - (1) Oil pan (Refer to page D-9.)
  - (2) Cap bolt and spring
  - (3) Control plunger
2. Install in the reverse order.
3. Check the engine for oil leakage and check the oil level.

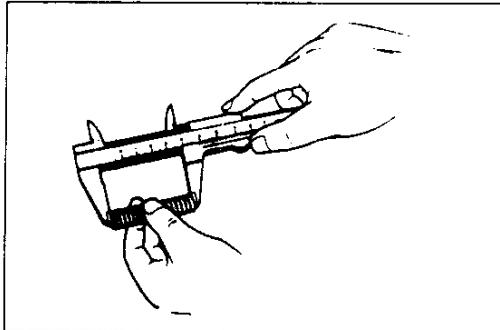

37U0DX-031

### INSPECTION

1. Check each part for damage and scoring. Replace if necessary.
2. Measure the free length of the spring, and if necessary, replace it.

**Free length: 73.0 mm {2.87 in}**

# D.

## METERING OIL PUMP

### METERING OIL PUMP

#### PREPARATION SST

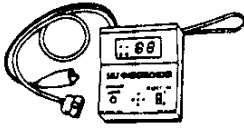
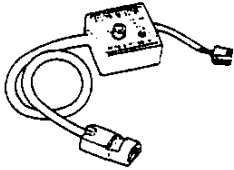
<p>49 H018 9A1</p> <p>Self-Diagnosis Checker</p> 	<p>For diagnosis of metering oil pump system</p>	<p>49 B019 9A0</p> <p>System Selector</p> 	<p>For diagnosis of metering oil pump system</p>
--	--	--	--

37U0DX-03C

Malfunctions related to the metering oil pump may be described as electrical component problems and mechanical component problems.

#### Electrical Component Related Problem

1. Check for service codes by using the **SST** (49 H018 9A1, 49 B019 9A0). (Refer to Section F.)
2. If Service Code No. 20, 26, 27 or 37 appears, check the metering oil pump following the diagnosis chart below.

#### Diagnosis Chart

37U0DX-033

Service Code No.	Possible Cause	Action
20 (Metering oil pump position sensor)	<ul style="list-style-type: none"> <li>● Open or short circuit in position sensor wiring</li> <li>● Open or short circuit in wiring between engine control unit and position sensor</li> <li>● Loose connection of position sensor or engine control unit</li> </ul>	Perform Inspection 2 (page D-16)
26 (Metering oil pump control system)	<ul style="list-style-type: none"> <li>● Open or short circuit in wiring between engine control unit and stepping motor</li> <li>● Loose connection of metering oil pump or engine control unit</li> <li>● Damaged stepping motor</li> <li>● Insufficient engine control unit voltage</li> </ul>	Perform Inspection 1 (page D-15)
27 (Metering oil pump control system)	<ul style="list-style-type: none"> <li>● Open or short circuit in wiring between engine control unit and stepping motor</li> <li>● Loose connection of metering oil pump or engine control unit</li> <li>● Damaged stepping motor</li> <li>● Position sensor inaccurate</li> <li>● Insufficient engine control unit voltage</li> </ul>	Perform Inspection 1 (page D-15)
37 (Battery voltage drop)	<ul style="list-style-type: none"> <li>● Malfunction of charging system</li> </ul>	Refer to Section G

37U0DX-034

#### Control Unit Terminal

4Y	4W	4U	4S	4Q	4O	4M	4K	4I	4G	4E	4C	4A	3O	3M	3K	3I	3G	3E	3C	3A	2K	2I	2G	2E	2C	2A	U	S	Q	O	M	K	I	G	E	C	A
4Z	4X	4V	4T	4R	4P	4N	4L	4J	4H	4F	4D	4B	3P	3N	3L	3J	3H	3F	3D	3B	2L	2J	2H	2F	2D	2B	V	T	R	P	N	L	J	H	F	O	B

37U0DX-035

**INSPECTION**

1. Metering oil pump control system

**Stepping motor resistance**

Measure the resistance at the following terminals. Is voltage as shown?  
(Reading must be A or B)

Terminals	Reading	A	B
+ B1 to S1 - S3	Open	16-31 Ω	
+ B2 to S2 - S4	Open	16-31 Ω	
+ B1 to S2 - S4	16-31 Ω		Open
+ B2 to S1 - S3	16-31 Ω		Open

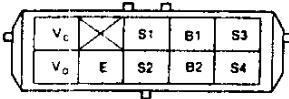

NO → Replace metering oil pump

YES

**Harness terminal voltage**

Turn ignition switch ON; is battery voltage indicated at terminals + B1 and + B2 of harness with connector disconnected?

NO → Repair or replace wiring harness

YES

**Harness and connector continuity**

Is there continuity between stepping motor and engine control unit as shown?

Stepping motor	Control unit
S1 (B/O)	4I
S2 (B/L)	4J
S3 (B/LG)	4K
S4 (B/Y)	4L

NO → Repair or replace wiring harness

YES

**Control unit terminal voltage (stepping motor)**

Turn ignition switch ON; is battery voltage indicated at terminals 4I, 4J, 4K, and 4L?

NO → Replace engine control unit

**Note**  
This test must be done with connector connected.

YES

**Control unit terminal voltage (position sensor)**

Turn ignition switch ON; is approx. 1-4.2V indicated at terminal 3A?

NO → Replace metering oil pump

YES

Is approx. 1.1V at idle?

YES

Does voltage increase from approx. 1.1V then return to approx. 1.1V when accelerating and decelerating engine?

NO → Replace metering oil pump

YES

**Position sensor operation**

Cancel memory of malfunctions by disconnecting negative battery cable for 20 seconds; then reconnect it  
Warm up engine unit coolant temperature reaches 80°C (176°F) and let it idle for 15 minutes  
Do Service Codes No. 26 or 27 appear?

YES → Replace metering oil pump

NO

Metering oil pump control system OK

# D

## METERING OIL PUMP

### 2. Metering oil pump position sensor

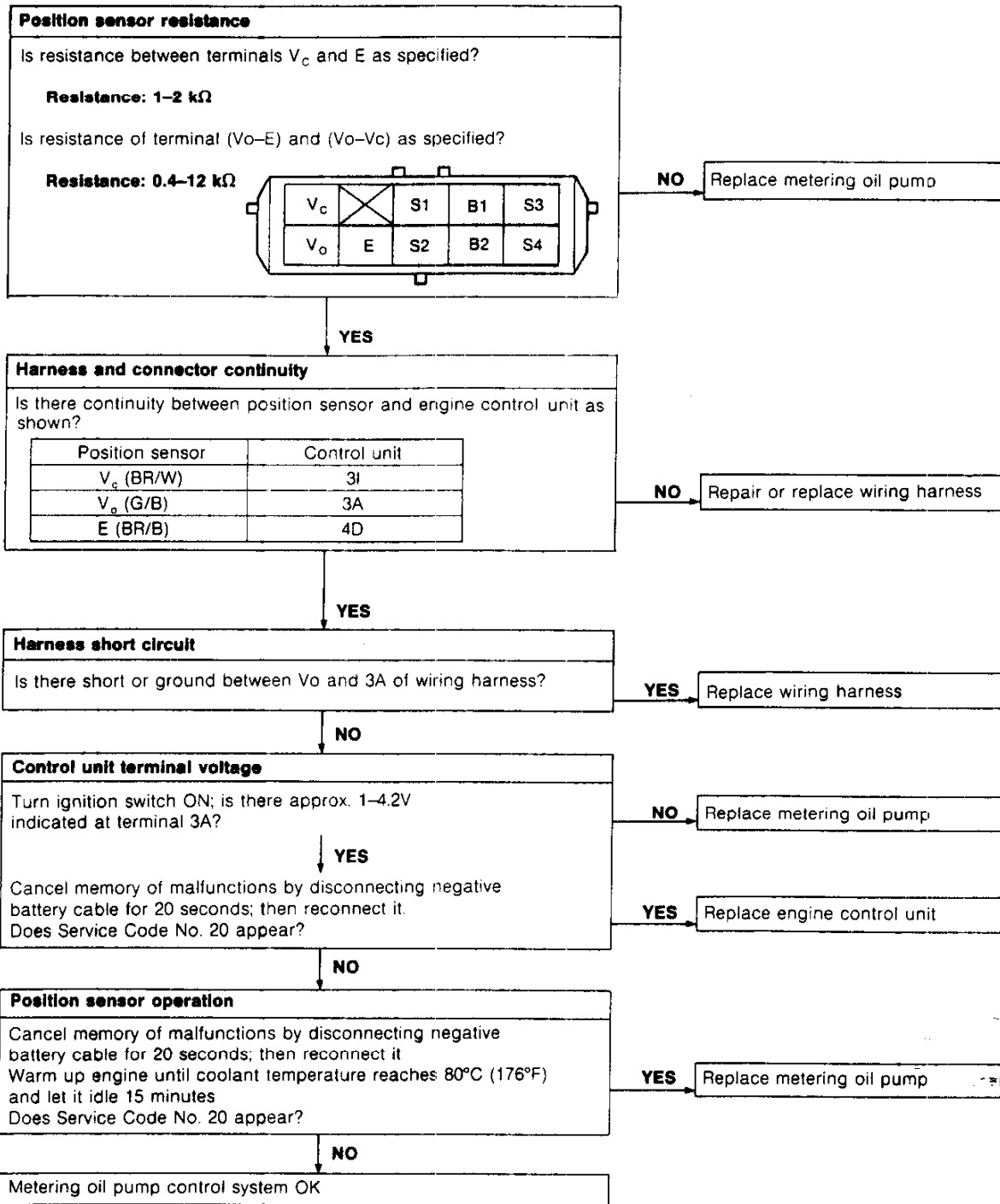

### Mechanical Component Related Problem

Excessive oil consumption may be caused by a metering oil pump malfunction. Before replacing the metering oil pump, refer to "Oil leakage" in the Troubleshooting Guide (page D-4) and perform the electrical component inspection (pages D-15 and D-16).

37U0DX-0:17



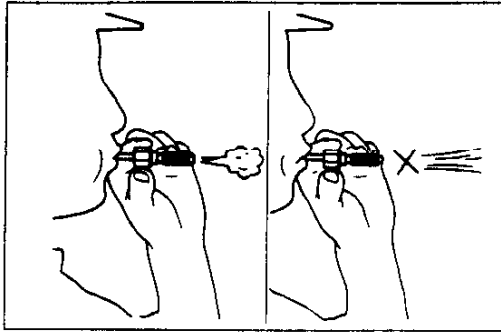

37U0DX-038

**Oil nozzle**

1. Remove the oil nozzles from the rotor housing and the intake manifold.
2. Verify that air passes in only one direction as shown. If not so, replace the oil nozzle.

**OIL PUMP**

**DISASSEMBLY / ASSEMBLY**

1. Disassemble in the order shown in the figure.
2. Assemble in the reverse order of disassembly, referring to **Assembly Note**.

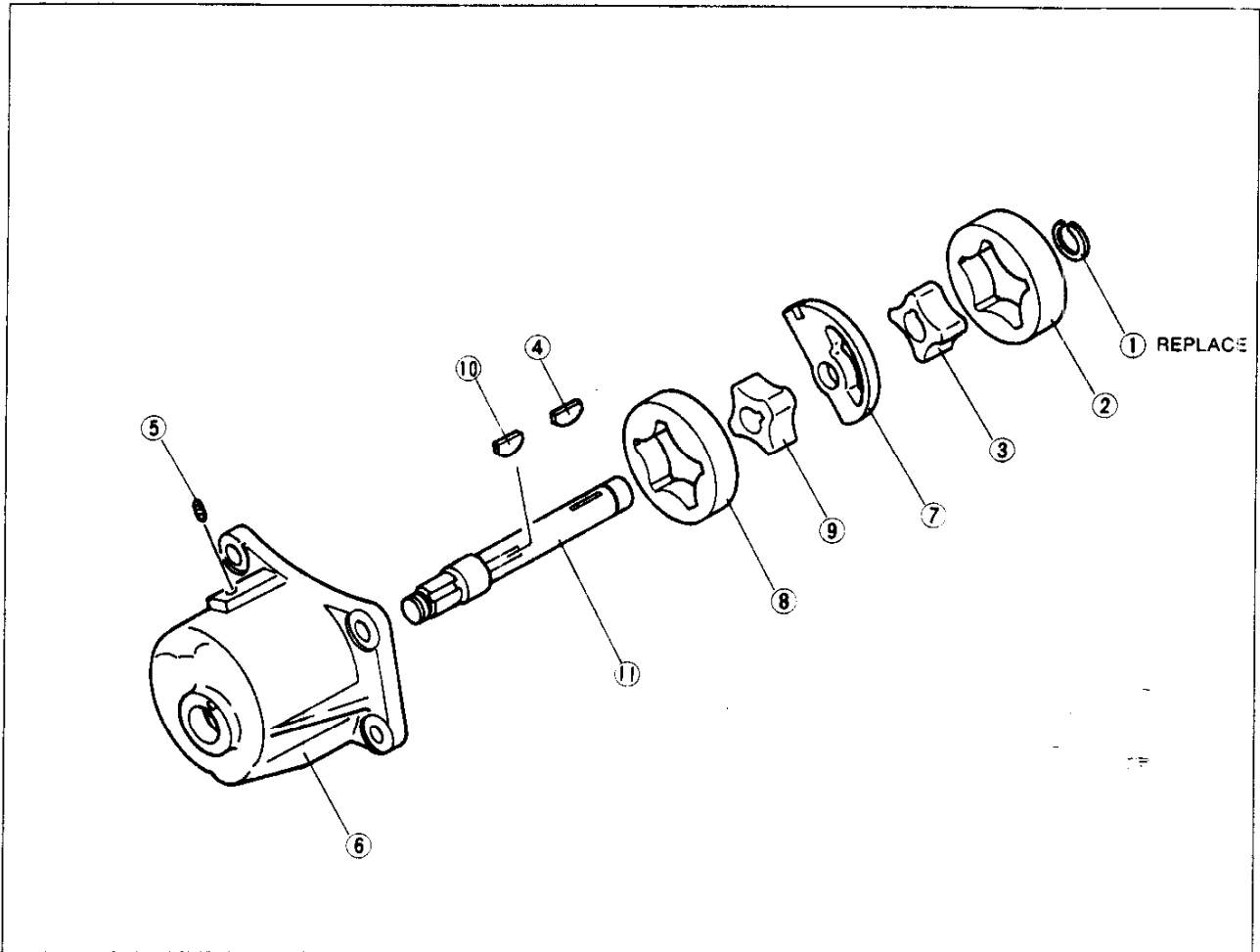

37U0DX-019

- |                     |                      |                      |
|---------------------|----------------------|----------------------|
| 1. Snap ring        | 5. Screw             | 9. Front inner rotor |
| 2. Rear outer rotor | Assembly Note        | Assembly Note        |
| Assembly Note       | ..... page D-19      | ..... page D-18      |
| ..... page D-18     | 6. Body              | 10. Key              |
| 3. Rear inner rotor | 7. Center plate      | 11. Shaft            |
| Assembly Note       | 8. Front outer rotor |                      |
| ..... page D-18     | Assembly Note        |                      |
| 4. Key              | ..... page D-18      |                      |

# D

## OIL PUMP

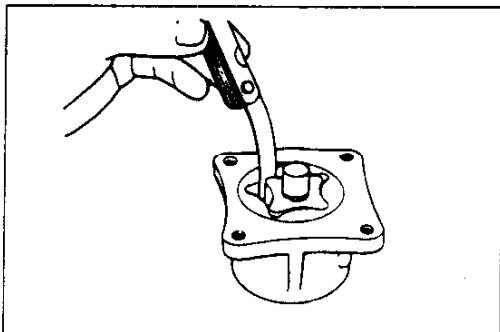

37U0DX-040

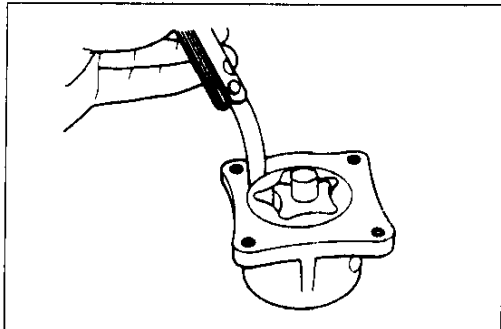

67U0DX-041

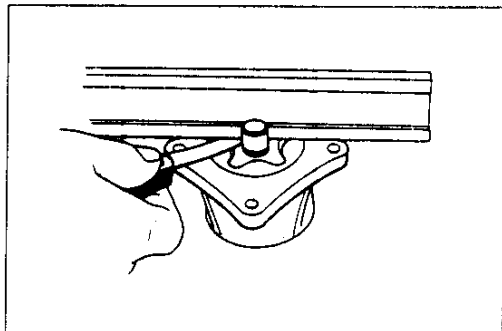

37U0DX-042

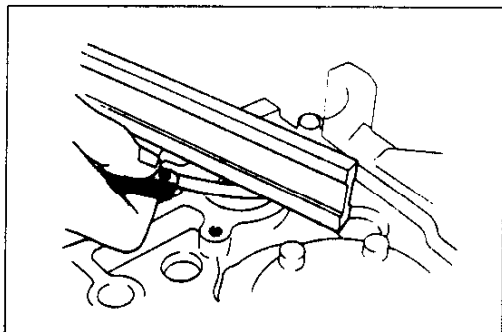

37U0DX-043

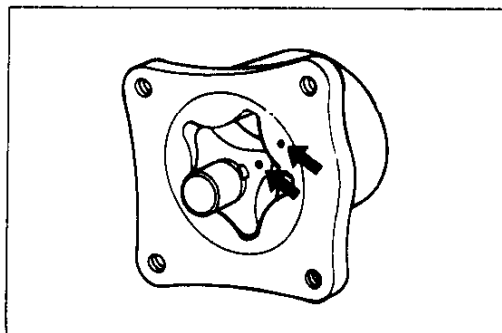

37U0DX-044

### INSPECTION

1. Inspect the oil pump parts for wear and damage. Replace as necessary.
2. Measure the clearance between the lobes of rotors by using a feeler gauge.

#### Standard clearance:

0.03–0.12 mm {0.0012–0.0047 in}

Maximum: 0.15 mm {0.0059 in}

3. Measure the clearance between the outer rotor and the pump body.

#### Standard clearance:

0.20–0.25 mm {0.0079–0.0098 in}

Maximum: 0.30 mm {0.0118 in}

4. Inspect the side clearance of the rotors.

(1) Using a straightedge and a feeler gauge, measure the depth of the rotor in the pump body.

(2) Measure the depth of the rotor sliding surface from the pump mounting surface.

(3) Add the two depth amounts to obtain the side clearance.

(4) If not as specified, grind or replace the pump body.

#### Standard end clearance:

0.03–0.125 mm {0.0012–0.0049 in}

Maximum: 0.15 mm {0.0059 in}

### Assembly Note

#### Outer rotor and inner rotor

Install the front and rear outer and inner rotors so that the tally marks on the rotors face the front housing.

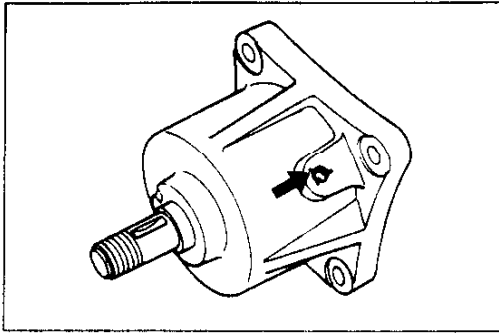

**Screw**

To prevent the screw from loosening, stake it after installation.

37U0DX 045

